

TRAINING GUIDE



Splendide
TECHNICAL EDUCATION
GROUP PRESENTS



WD2100XC / XCP (Splendide 2100XC)
WDC7100XCP (Splendide 7100XC)

Front-Loading Automatic Washer-Dryer

Training Guide

Part No. TRAINMANXC

Contact Info

Product Specifications & Warranty Info

Westland Sales, Splendide Tech Dept.
1-800-356-0766 EXT. 5
(503-655-2563)

Technical Assistance & Parts Ordering

Westland Sales, Splendide Tech Dept.
1-800-356-0766 EXT. 5
(503-655-2563)

Literature Orders

Westland Sales, Splendide Tech Dept.
1-800-356-0766 EXT. 5
(503-655-2563)

Corporate Headquarters

15650 SE 102nd Ave.
(PO BOX 427)
Clackamas, OR 97015

Telephone: 800-356-0766 (503-655-2563)

Service Fax: (503) 722-9202

Service E-mail: service@splendide.com

www.splendide.com/support.htm

Introduction

Westland Sales assumes no responsibility for repairs on Splendide products by anyone other than Authorized Splendide Service Technicians. Warranty repairs must be pre-approved by Splendide. Contact Westland Sales, before servicing any Splendide appliance.

This Training Guide for the “Splendide Front-Loading Automatic Washer-Dryer,” (Part No. TRAINMANXC), provides the service technician with information on the installation and service of Splendide washer-dryer models WD2100XC and WDC7100XC. It is to be used as a supplemental training aid for service technicians. For more information on the washer-dryer, refer to the “Use and Care Guide” provided with the appliance.

Training Guide Goals

The goal of this Training Guide is to provide information that will enable the service technician to properly diagnose malfunctions and repair the Splendide Front-Loading Automatic Washer-Dryer.

The objectives of this Training Guide are for the service technician to:

- understand and follow proper safety precautions,
- effectively troubleshoot and diagnose malfunctions,
- successfully perform necessary repairs, and
- help the technician to quickly return the washer-dryer to its proper operational status



© Copyright 2004, Westland Sales, Clackamas, OR 97015

Contents

1. General Information	1	
Model / Serial Number Designators		1
Warranty Guide		2
Washer-Dryer Specifications		3
IMPORTANT General Safety Information		4
2. Installation Information	5	
Installation Requirements		5
Installation Instructions		9
3. Theory of Operation	13	
Introduction to the Models		13
Water System		13
Wash/Dry System		15
Door Lock / Switch Assembly		17
Suspension System		17
Customer Interface / Cycle Selection System		18
Automatic Routines		24
4. Accessing the Components	27	
Component Locations		27
Top Panel / Control Panel Knobs		28
Control Panel Board / Control Panel		29
Door / Door Switch / Porthole Diaphragm		30
Detergent Dispenser Assembly / Water Valves		31
Pressure Switch		32
Fan Motor / NTC Sensor / Heater Coil		33
Removing the Heater Coil		34
Lower Panel / Drain Pump / Pump Filter		35
To Clean Out the Large Item Filter		36
Back Panel / Main Motor / Module Board		37
Shock Absorbers		38

(Continued on the next page)

5. Component Testing Procedures	39	
Connector Locations on the Module Board		39
Introduction / Instructions		40
1. Door Switch Test		41
2. Power “in” from the Surge Protector Test		42
3. Pressure Switch Test		43
4. Heating Element Test		44
5. Main Motor Test (<i>Includes Running the Main Motor with AC Voltage</i>)		45
6. Fan Motor / Water Pump Test		46
7. Water Valve / Wash NTC Test		47
8. Control Panel Board Test		48
9. Dry NTC Sensor Test		49
6. Diagnosis & Troubleshooting	50	
Introduction		50
Explanation of Fault Codes		51
Fault Code / Testing Procedure Chart		52
Problem / Testing Procedure Chart		54
7. Tech Tips	56	
Manually Unlocking the Door		56
Performing a Dryer Airflow & Heat Test		56
Winterization Instructions / Optional RV Winterization		57
Verifying Normal Operation		58
8. Wiring Diagrams	59-61	

General Information

Model / Serial No. Designators

Use these numbers to obtain the Warranty status as well as a history of repairs and service calls for the washer-dryer.
To speed the repair process, ALWAYS have the Model and Serial No. ready when you call Westland Sales.

Model Number

WD

C

7100XC

p

PRODUCT GROUP
WD = Washer-Dryer

PRODUCT IDENTIFICATION
C = Condenser Drying System (Ventless model)

PRODUCT CODE

PRODUCT COLOR Arctic White if not noted (P = Platinum)

Serial Number

S/N

7

07

14

3277

YEAR OF MANUFACTURE

MONTH OF MANUFACTURE

DAY OF MANUFACTURE

PRODUCT SEQUENCE NUMBER



Model Number



Serial Number

Warranty Guide*

Refer to this page for a brief summary of the Product Warranties available by Splendide.

Wty Length	Splendide Will Pay For	Splendide WILL NOT Pay For
MFR 1-YEAR From Date of Purchase	Replacement parts ONLY.	A. Repairs when the washer-dryer is used in other than normal, single-family use. B. Pickup and delivery. The washer-dryer is designed to be repaired on-site. C. Removal/replacement of washer-dryer from built-in or cabinet installations. D. Damage to the washer-dryer caused by accident, alterations, misuse, abuse, fire, flood, acts of God, or use of products not approved by Splendide. E. Repairs to parts or systems resulting from unauthorized modifications made to the washer-dryer. F. Replacement parts or repair labor costs not pre-approved by Splendide and/or provided by an unauthorized service company. G. Service calls to correct the installation of the washer or to instruct you how to use it. H. Plastic parts and cosmetic pieces.*
LIMITED 1-YEAR** From Date of Purchase (Not available for some models)	For 1 year from the date of purchase WHEN product is registered. Limited replacement parts and repair labor costs.	
LIMITED 2-YEAR** From Date of Purchase (Not available for some models)	For two years from the date of purchase WHEN extended Protection Plan is purchased. Limited replacement parts and repair labor costs.	
LIMITED 5-YEAR ** From Date of Purchase (Not available for some models)	For five years from the date of purchase WHEN extended Protection Plan is purchased.	

*IMPORTANT!

This chart should be used ONLY as a guide and DOES NOT supersede the Warranty Statement. For complete information, refer to the Warranty Statement that came with the appliance.

** Coverage starts 60 days after warranty registration or warranty registration with full payment is received by Westland Sales.

Washer-Dryer Specifications

The following is a list of product specifications for the Splendide Models covered in this Training Guide.

Model Number	WD2100XC / WD2100XCP	WDC7100XCP
COLOR	White	Platinum
DRYER TYPE	Vented	Ventless
ELECTRICAL REQ.		
Max. Current	11A	11A
Rated Current	15 A	15 A
Voltage	120V	120V
Frequency	60Hz	60Hz
Heating Power	1300W	1300W
GALLONS WATER PER †Regular Cotton Heavy Duty/ cycle*	7.5 Gal.	7.5 Gal.
MAX. LOAD CAPACITY		
Wash	15 lb.	15 lb.
Dry	11 lb.	11 lb.
MAX. SPIN SPEED	1200 RPM	1200 RPM
Height	33 1/4"	33 1/4"
Width	23 1/2"	23 1/2"
Depth	22 3/16"	22 3/16"
WEIGHT	148 lb.	148 lb.
PROGRAMS		
Wash	9 Cycles	9 Cycles
Dry	3 Cycles	3 Cycles
WASH TEMP OPTIONS	7	7
SPECIAL WASH OPTIONS	4 buttons	4 buttons

*Avg. wash water use is 7.5-16 gal/wash load. Water usage varies depending on load size and fabric type.

NOTE: WDC7100XC has a condenser (ventless) drying system. This condenser drying system uses 2.5 gallons of cold water per hour during the dry cycle.

IMPORTANT General Safety Information



Your safety is important. Read this section before you continue.



Important safety messages can be found in this manual and on the appliance. Always read and obey all safety messages.





This is a safety alert symbol. This symbol alerts you to potential hazards that can kill or hurt you and others. All safety messages will follow the safety alert symbol and the word "WARNING."

The safety messages will tell you what the potential hazard is, tell you how to reduce the chance of injury, and tell you what can happen if the instructions are not followed.

 WARNING	
	ELECTRICAL SHOCK HAZARD Disconnect power before servicing. Replace all panels before operating. Failure to do so can result in death or electrical shock.

 WARNING	
	EXCESSIVE WEIGHT HAZARD Use two or more people to move and install the washer-dryer. Failure to do so can result in back or other injury

 WARNING	
	ELECTRICAL SHOCK HAZARD Plug washer-dryer into a grounded 3 prong outlet. Do not remove ground prong. Do not use adapter. Do not use an extension cord. Failure to follow these instructions can result in death, fire, or electrical shock.

Electrostatic Discharge (ESD)

Sensitive Electronics

ESD problems are present everywhere. ESD may damage or weaken the electronic control assembly. The new control assembly may appear to work well after repair is finished, but failure may occur at a later date due to ESD stress.

- Use an antistatic wrist strap. Connect the wrist strap to a green ground connection point or unpainted metal in the appliance; or touch your finger repeatedly to a green ground connection point or unpainted metal in the appliance.
- Avoid touching electronic parts or terminal contacts. Handle the Module Board by the plastic housing ONLY.

Installation Information

Installation Requirements

Check these location, plumbing and electrical installation requirements for a proper washer-dryer installation.

Electrical

- Machine Voltage/Amperage - 120V, 60 Hz, 1300 W, 10.5 Amp.
- Connection - 3-prong plug with 6' cord is provided with the machine.
- Circuit/Protector - 3-wire single phase, 120V, 60 Hz, AC, on a separate 15 Amp circuit.

Location

- This machine may be installed free standing as well as in a recessed area, closet, or alcove
- **Minimum Installation Spacing** - 0" on sides and 1" in front and back. NOTE: Additional installation spacing needs to be considered for easy installation, servicing, and compliance with state and federal codes.
- **Floor** - Must support at least 280 lbs. and be a solid, level surface. DO NOT install on carpet.
- **RV/Marine Installations** - When locating the appliance in a towable trailer or watercraft, position the machine over the axles or mid-ship where movement is at a minimum. Block the machine to prevent extreme movement.
- **Exhaust Requirements (WD2100XC Model ONLY)** - Rigid or flexible metallic duct required. Ducting should be as short and straight as possible. DO NOT exhaust dryer into a chimney, furnace, cold air duct, attic crawl space, or another duct used for venting. If a cabinet door is installed, a minimum of 8 sq. in. should be provided for make up air. Louvered doors with equivalent air openings are acceptable. Allow clearances behind door(s) to avoid rubbing between back of cabinet door(s) and front of unit control panel. Additional clearances for wall, door and floor moldings may be required.

If you have...	You'll need...
no access to Hot/Cold water hookups	Splendide Faucet Adapter Kit, or equivalent.
to install a dryer vent and ducting in your RV or boat	Splendide Vent Kit, or equivalent.
concerns about the appliance shifting in your RV or boat	Splendide SecureFit bracket kit, or equivalent.
water damage concerns	Splendide Drain-A-Way Pan, or equivalent.
to make a 90° duct turn in less than 4.5"	Splendide 90° offset elbow, or equivalent.

Drainage

- **Standpipe Diameter/Capacity** - Needs a 1 ¼" minimum diameter standpipe with a minimum carry-away capacity of 7 gallons per minute.
- **Top of Standpipe** - Must be between 25" and 34" high from the bottom of the machine.
- **Outlet End of Drain Hose** (provided with the unit) - Must be at least 20" above the bottom of the washer-dryer. An air break must be available at the standpipe to avoid siphoning. No more than 6" of the drain hose should be inserted into the drain pipe to prevent siphoning.

Washer-Dryer Dimensions

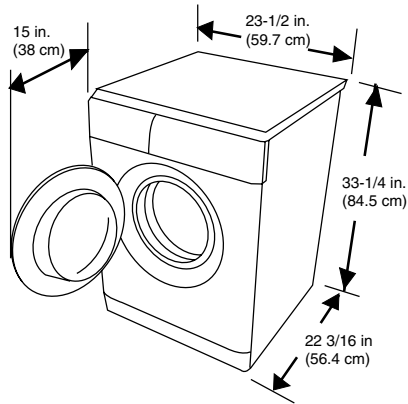

Undercounter Install Requirements

The dimensions shown are for the minimum spacing allowed.

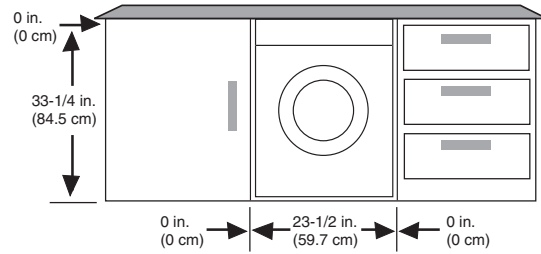

Recessed Area/Closet Install Requirements

The dimensions shown are for the minimum spacing allowed.

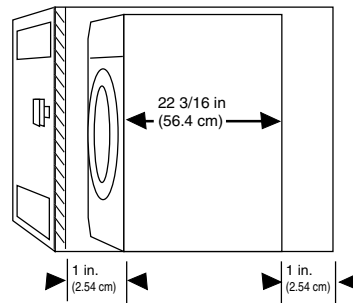

Additional spacing should be considered for:

- Ease of installation and servicing.
- Additional clearances might be required for wall, door and floor moldings.
- If cabinet door is installed, a minimum of 8 sq. in. should be provided for make up air. Louvered doors with equivalent air openings are acceptable.

Drain System Requirements

The washer-dryer can be installed using the standpipe drain system, floor drain system or the sink drain system. To prevent siphoning, the outlet end of the drain hose **MUST** always be 20" (50.8 cm) above the base of the machine. Not more than 6" (15.24 cm) of the drain hose should be inserted into the drain pipe.

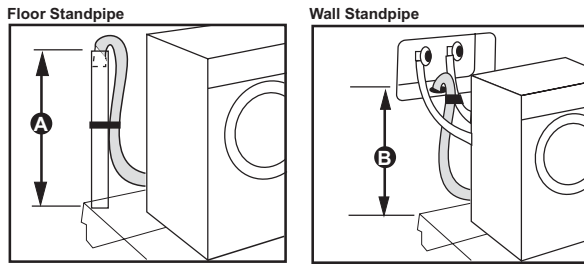

A & B = 25" (62 cm) min. / 34" (86 cm) max.

The standpipe drain requires a minimum diameter standpipe of 1-1/4" (3.2 cm). The minimum carry-away capacity can be no less than 7 gal (26.5 L) per minute.

The top of the standpipe must be at least 25 in. (62 cm) high and no higher than 34" (86 cm) from the bottom of the washer.

The floor drain system requires a siphon break that may be purchased separately.

The sink drain system connected to a garbage disposer requires a "Y" connector (sold separately).

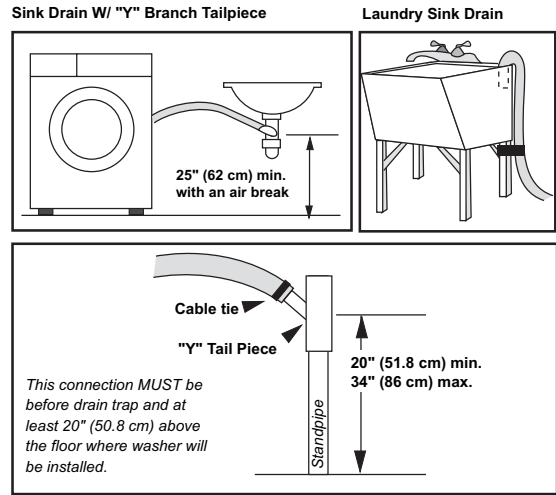
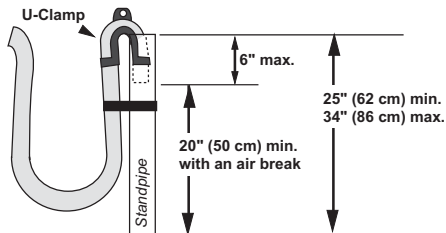

Floor Standpipe w/ "Y" Branch Tail Piece

Optional

- The Splendide Faucet Adapter Kit, Part No. 154187104A
- Supplies water from the faucet and discharges water directly into the sink.
- Designed for installations where washer-dryer hook-ups are not available.



Faucet Adapter Kit, Part No. 154187104A

(Continued on the next page)

Electrical Requirements

GROUNDING INSTRUCTIONS

This appliance must be grounded. In the event of a malfunction, or breakdown, grounding will reduce the risk of electric shock by providing a path of least resistance for electric current. This appliance is equipped with a cord having an equipment grounding conductor and grounding plug. The plug must be plugged into an appropriate outlet that is properly installed and grounded in accordance with all local codes and ordinances. **DO NOT** modify the plug provided with the appliance. If it will not fit the outlet, have the proper outlet installed by a qualified electrician.

WARNING: Improper connection of the equipment-grounding conductor can result in a risk of electric shock. Check with a qualified electrician or serviceman if you are in doubt as to whether the appliance is properly grounded.

WARNING



ELECTRICAL SHOCK HAZARD

Plug washer-dryer into a grounded 3 prong outlet.

Do not remove ground prong.

Do not use adapter.

Do not use an extension cord.

Failure to follow these instructions can result in death, fire, or electrical shock.

- A 120-volt, 60-Hz., AC-only, 15 or 20-amp, fused electrical supply is required. Time-delay fuse or circuit breaker is recommended. It is recommended that a separate circuit serving only this appliance be provided.
- This washer-dryer is equipped with a power supply cord having a 3-prong ground plug.
- To minimize possible shock hazard, the cord must be plugged into a mating, 3-prong, ground-type outlet, grounded in accordance with local codes and ordinances. If a mating outlet is not available, it is the personal responsibility and obligation of the customer to have the properly grounded outlet installed by a qualified electrician.
- If codes permit and a separate ground wire is used, it is recommended that a qualified electrician determine that the ground path is adequate.
- Do not ground to a gas pipe.
- Check with a qualified electrician if you are not sure the washer is properly grounded.
- **DO NOT** use an extension cord.
- Do not have a fuse in the neutral or ground circuit.
- **DO NOT** install or store this appliance where it will be exposed to weather or in an area where gasoline or other flammables are stored.

Installation Instructions

Follow these instructions in order to prevent installation errors and to assure proper washer-dryer operation.

Unpacking the washer-dryer

- Carefully remove the packing materials with care not to damage the drain hose and power cord that are shipped installed on the machine. Check that the machine is intact. Report any damage immediately.
- Position the washer-dryer near the desired installation position.



WARNING: Plastic bags, styrofoam, nails and other packaging parts are not children's toys and can be potentially dangerous. Destroy the carton and plastic bags after the washer-dryer has been unpacked.

Removing the transit screws

For transportation, the inside of the machine is supported by screws, rubber grommets and spacers on the back panel. Before using the washer-dryer, these items MUST be removed.



IMPORTANT: Transit screws and spacers must be removed before operating the machine to allow proper operation of the machine and to prevent damage to the appliance.

- After positioning the washer-dryer near the installation location, remove the four screws (Fig.1), with the rubber grommets and plastic spacers that are attached to them.
- Use the plastic plugs (provided in the accessories bag) to fill in the holes.

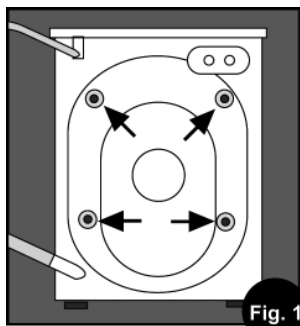

IMPORTANT: Retain the transit screws, spacers and rubber tubes. These items should be reinstalled to prevent damage if or when you transport the machine in the future.

Connecting the water inlets

If the water pipes you will be connecting to are new or unused, run the water until clear to remove any debris that could clog the water valve screens or valves before connecting the machine. NOTE: Supply shut-off valves should be easily accessible.



IMPORTANT: Water pressure MUST range within the values indicated on the "Technical Data" chart

- Included in the accessories supplied with your machine are 2 inlet hoses with 4 rubber washers pre installed. Check that the rubber washers are installed in the ends of the inlet hoses to make a water tight seal at each connection point.
- Connect the straight ends of the water inlet hoses to the supply taps that have $\frac{3}{4}$ " BSP thread (standard hose bib).
- Connect the 90° angled ends (20 mm thread) of these hoses to the inlet valves

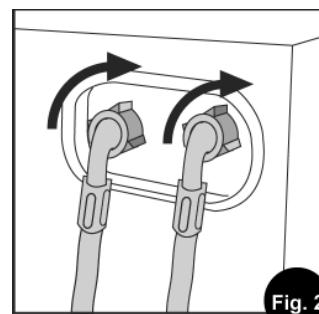

- on the back of the machine (Fig. 2). NOTE: Water Inlet valves are color coded: Red (Hot) & White (Cold).



IMPORTANT: Do not use excessive force. Damage to the couplings can result. The couplings should be tightened by hand; a tool should only be used if a leak occurs.

Connecting the drain hose

It is possible for the water to be discharged into a sink, standpipe or drainpipe, but an air break must be available at a minimum 20" height to prevent the machine from siphoning (Fig. 6).

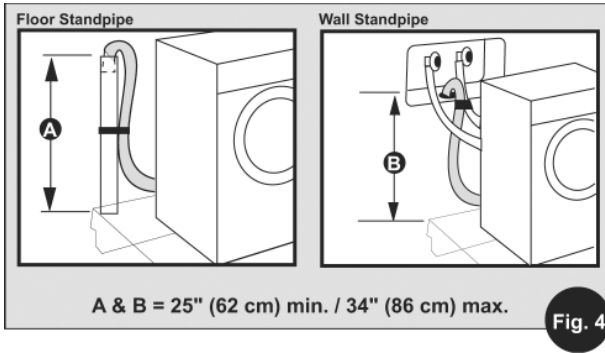

Standpipe Drain System - Installations require a minimum 1 1/4" (3.2 cm) diameter standpipe with a minimum carry away capacity of 7 gallons (26 liters) per minute. Wall or Floor Standpipe Drain System - The top of the standpipe must be between 25" (62 cm) - 34" (86 cm) from the bottom of the washer (Fig. 4).

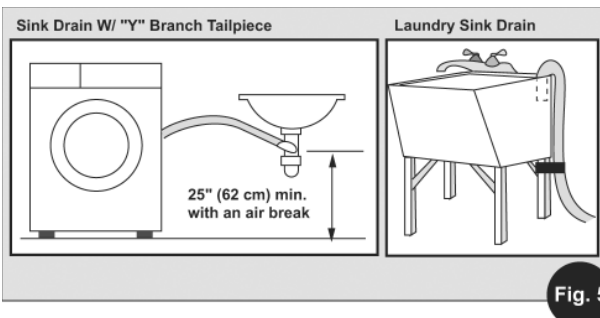

Sink Drainpipe System - Entry into the sink drain system must be above the trap (Fig. 5). When routing the drain hose through cabinets or walls, use a protective material such as electrical or duct tape to cover sharp edges that could damage the drain hose. Use a suitable clamp to secure the drain hose to the "Y" branch or the disposer (Fig. 7). With a sink drainpipe system, you may connect directly: 1) to a disposer by following the manufacturer's attachment method. 2) directly to a "Y" branch tail piece (available at most hardware stores). 3) Through

the floor to a separate trap. The trap must be vented to prevent siphoning. To provide proper venting, install an Air Gap Kit (available at most hardware stores).

4) To the faucet using a Faucet Adapter Kit (available separately).



IMPORTANT: Make sure that the drain hose is not kinked and that water flow is not restricted.

- Use a U-Clamp (provided in your accessories packet) or suitable item to secure the outlet end of the drain hose (pre-installed on the back of your machine).
- Insert the outlet end of the drain hose into the standpipe, wall or floor drain (Fig. 6). NOTE: The outlet end of the drain hose **MUST** be at least 20" (50 cm) above the base of the machine. No more than 6" of the drain hose should be inserted into the drain pipe to prevent siphoning.
- Use a strap, cable tie, or similar item to hold the hose or the U-Clamp in place.

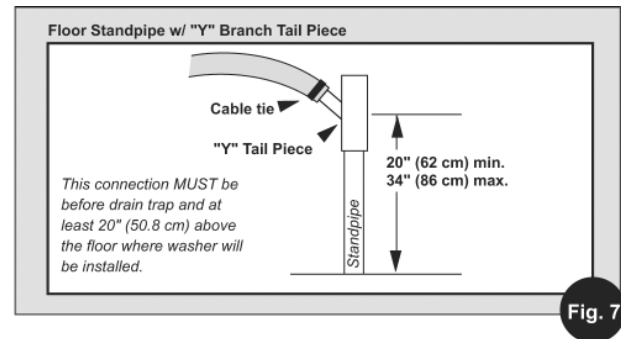
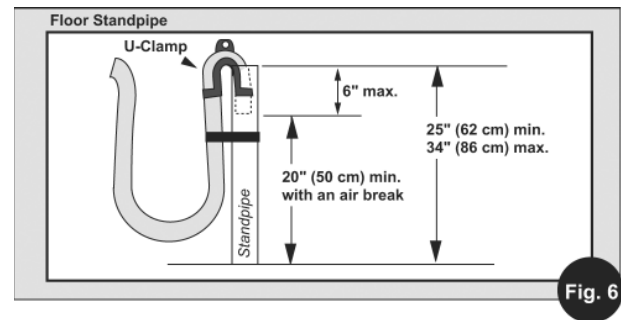

Installing the exhaust ducting (WD2100XC Model ONLY)



IMPORTANT: This appliance should **NOT** be exhausted into a chimney, wall, ceiling, or any concealed space of a building. Only rigid or flexible metallic ducting should be used.

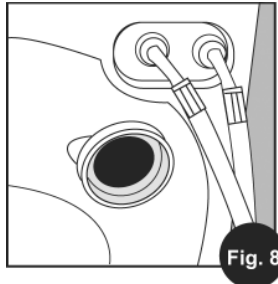

- Rigid or flex metal/metallic ducting should be used.
- Exhaust ducts should be as short and straight as possible. *NOTE: Long exhaust ducting can extend drying time, collect lint and may affect drying performance.*
- The exhaust duct must end with an approved exhaust vent hood with swing out damper(s) or tailpiece with louvers.
- Check that all ducting is clean and lint free. Use duct tape or screw clamps to secure all joints.
- Use duct tape or screw clamps to secure the duct to the round flange vent located on the back of the machine (Fig. 8).



WD2100XC WARNING! -To reduce the risk of fire, this appliance must be exhausted to the outdoors.

Rigid or flexible metallic duct required. Ducting must be as short and straight as possible.

Do not exhaust dryer into a chimney, furnace, cold air duct, attic crawl space, or another duct used for venting.

If a cabinet door is installed, a min. opening of 8 sq. in. should be provided for make up air. Louvered doors with equivalent air openings are acceptable. Allow clearances behind door(s) to avoid rubbing between back of cabinet door(s) and front control panel. Additional clearances for all, door and floor molding may be required.

Leveling the washer-dryer (All Models)

- To access the front leveling legs, tilt the machine backwards, leaning it against a wall or other stable structure.
- Adjust the legs up or down (Fig. 9) to ensure the washer is resting solid and does not rock side-to-side or front-to-back when the machine is upright.
- Check that the angle of inclination, measured according to the work top, does not exceed 2°.

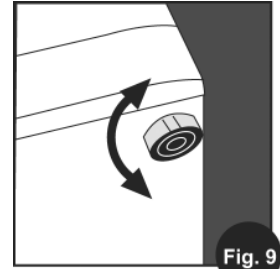

IMPORTANT: The machine must rest solid on a sturdy floor for optimum performance and minimum vibration.

Completing the installation

- Check the electrical requirements. Be sure that you have the correct electrical supply and the recommended grounding method.
- Check that the shipping brackets have been removed.
- Check that the water faucets are ON.
- Check for leaks around faucets and inlet hoses.
- Plug washer into a grounded 3-prong outlet.
- Slide the washer-dryer to its final location and confirm that it's level.
- When installing this appliance in an RV or marine vessel, you should block in the unit to prevent it from shifting or tipping. A SecureFit Bracket Kit is available from Splendide to keep the unit from shifting front-to-back or side-to-side.
- Test and clean the washer. Run a test load with no laundry.

Testing and cleaning the washer,

- Press the ON-OFF button to turn the washer ON
- Pour 1 to 2 TBSP of powder detergent into the detergent dispenser compartment '2'
- Select wash program '2'.
- Make sure the DRY TIME knob is in the 'OFF' position.
- Then press START. Allow the washer to complete the wash cycle.

Theory of Operation

Introduction

The Splendide Front-Loading Washer-Dryer models present many new features and characteristics that are different from previous models. In addition to the introduction of electronic controls, the washer-dryer contains a number of unique operating features designed to offer extremely high water and energy conservation while increasing fabric cleaning results.

Water System

The water system consists of the hot and cold water inlet valves and the dispenser distribution system along with a traditional pressure switch.

Water Inlet Valves

The hot and cold water inlet valves are located at the back, top-left of the washer. These valves receive a control signal from the Module Board to manage the temperature of incoming water. The temperatures are determined by the specific wash temperature selected. (See chart on next page)

Dispenser Distribution System

All wash and rinse water is introduced into the drum through a Dispenser Distribution System that diverts the incoming water to one or more of the follow water inlet modes: Detergent Dispensing, Bleach Dispensing, Fabric Softener Dispensing. The dispenser drawer has three separate compartments (plus one removable bin) for adding laundry products to the wash load. These compartments are:

1. Prewash Detergent (w/removable Bleach Bin)
2. Main Wash Detergent
3. Fabric Softener Compartment

All of the water flows through the dispenser assembly. Laundry products are diluted and dispensed automatically at the proper time during the wash cycle. Refer to "Use and Care Guide" that came with the appliance for proper use of laundry aids.

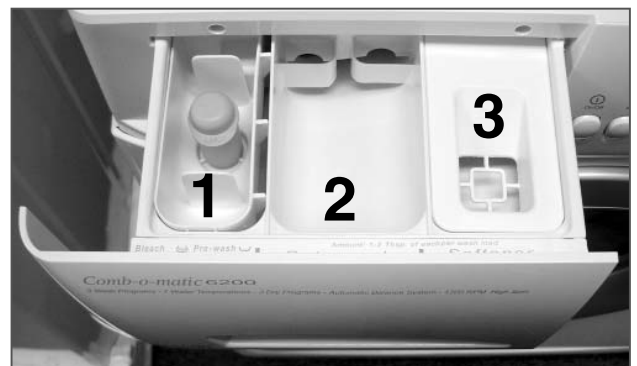

Dispenser Drawer

Pressure Switch

The pressure switch is located in the top, right-front corner of the washer. This switch senses the water level in the drum. The control signal from the pressure switch is sent to the Module Board and is used to determine the amount of water introduced into the drum during the wash cycle.

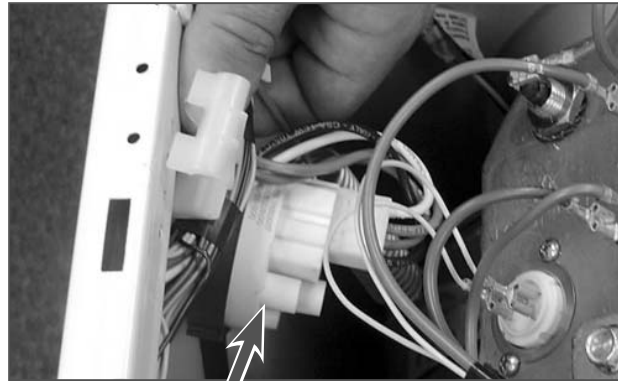

Pressure Switch

WASH TEMP Knob	Position	Wash Temp.*
HOT (Red)	1:30	140°F / 60° C
	3 o'clock	131°F / 55° C
WARM (Grey)	4:30	122°F / 50° C
	6 o'clock	104°F / 40° C
COLD (Blue)	7:30	95°F / 35° C
	9 o'clock	86°F / 30° C
	10:30	FROM COLD VALVE ONLY
	12 o'clock	FROM COLD VALVE ONLY

**NOTE: Actual wash water temperatures may vary depending on the temperature set at the water heater. Rinse temperatures are ALWAYS COLD.*

Wash/Dry System

The Wash/Dry System consists of the Module Board, the Main Motor, the Pump Motor and the Dryer Heating Element.

Module Board

The Module Board is located at the bottom, right-rear corner of the washer-dryer. If diagnostic tests indicate that the module board is defective, the entire module board must be replaced.

The module board receives input from the Control Panel/LED assembly and directly controls the dispenser, drain pump, water inlet valves, door locking and unlocking, fan motor and heating element relay. The module board monitors the pressure switch, and door lock switches.

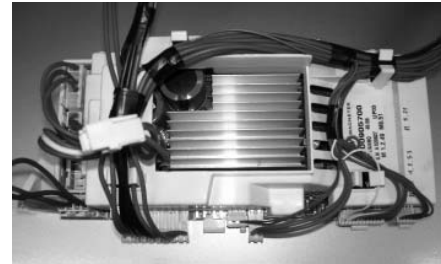

Main Motor

The main motor is located at the bottom, rear of the washer and is an infinite speed, 3 phase brushless motor that operates at various speeds and directions based on input voltages from the module board.



Main Motor

(Continued on the next page)

Pump Motor

A separate pump/pump motor is used to drain the drum (Fig.3-1).The pump motor is 120 VAC and is attached directly to the pump. The pump has a filter located at the bottom-front that allows for the removal of large objects like keys and coins that may have passed from the basket. (Fig. 3-2)



Fig. 3-1

Drain Pump



Fig. 3-2

Large Object Filter

Dryer Heating Element

The Dryer Heating Element is located in the heater duct assembly on the top-right of the drum. The Module Board provides power to the element in the dry cycle. During the dry cycle:

- **Vented model** (WD2100XC) take air from the surrounding room, heat it, tumble it through the clothes, and then exhaust it to the outside through a vent.
- **Ventless model** (WDC7100XC) require 2.5 gallons of cold water per hour during the dry cycle. (See below.)

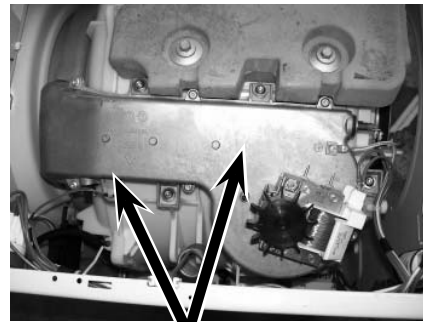

Dryer Heating Element

How Does Ventless Drying Work?

1. As damp laundry tumbles, the inner drum is heated. Heat draws the moisture out of the laundry in the form of STEAM.
2. Cold water cools the OUTER TUB. The cold surface attracts the warm, saturated air. STEAM passes through the holes in the INNER DRUM to reach the OUTER TUB.
3. When the STEAM hits the cooled surface of the OUTER TUB, it's condensed back into water. The water is then pumped out the drain. Process repeats until clothes are dry.

NOTE: Do not attempt to dry less than 2.2 lbs of laundry during the Cotton Heavy Duty Dry cycle.

Door Lock/Switch Assembly

The Door Lock/Switch Assembly is located on the right side of the door opening. The assembly contains a solenoid operated latching mechanism that will electrically lock the door during a wash or dry cycle.



Door Lock/Switch Assembly

Suspension System

The drum assembly is held in position with two shock absorbers attached to the bottom sides of the tub assembly. In addition, the drum is suspended from the top frame of the washer with three springs attached to the sides of the case.

Stability for this suspension system is provided by two concrete counter weights. One is located at the top and one at the bottom-front of the outer drum.

Springs

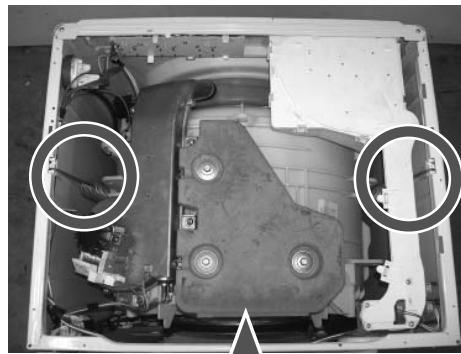

Top Counter Weight

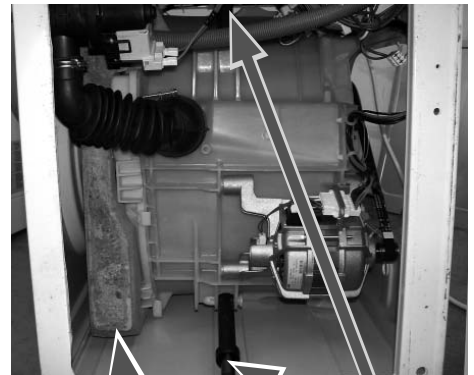

Bottom/Front Counter Weight

Shock Absorbers

Customer Interface / Cycle Selection System

The Customer Interface / Cycle Selection System consists of the Control Panel/LED Assembly along with the program timer, option buttons, and Wash Temperature and Dry Time Selectors.

Control Panel/LED Assembly

The Control Panel/LED Assembly (Fig. 3-3) is removed as a single assembly and is connected to the Module Board by 5 connection points to the wiring harness.

The assembly contains all the buttons, LED's and switches for the user to operate the washer-dryer. This interfaces what the consumer commands to the Module Board.

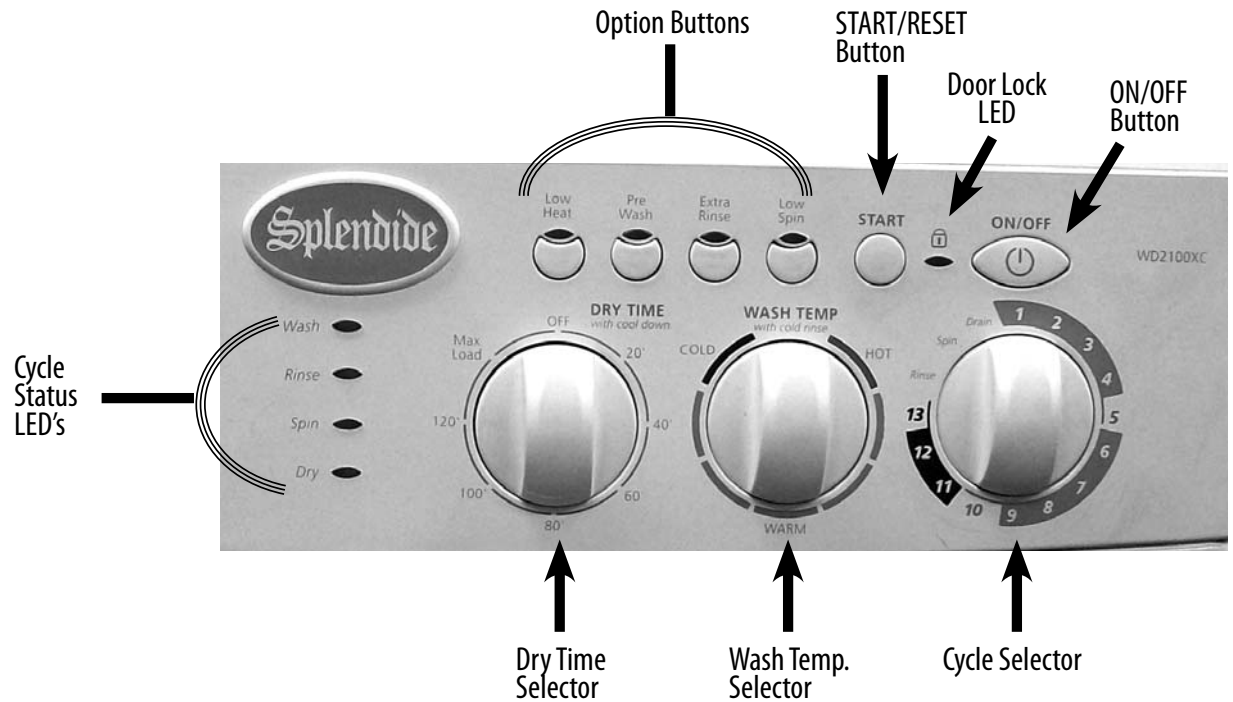

Fig. 3-3

Description of Control Panel Buttons, Knobs & LED's

ON/OFF Button- Use the ON/OFF Button to turn machine power ON or OFF

START Button- Use this button to START a cycle (press once) or RESET the controls (press and hold for 5 seconds). For more information, see "Resetting the Controls" on page 20.



Option Buttons - Use these buttons to modify the wash cycle (see "Description of Option Buttons")

Door Lock Light - This light indicates when the door is locked (LIT SOLID) and when it can be safely opened (BLINKING).

Water Temperature Selector - Choose a water temperature by turning the knob to the desired selection. Refer to the garment label and choose the warmest water safe for the fabric. Choose a slightly lower temperature to get the same wash results while saving energy. NOTE: Rinse is always COLD.

Dry Time Selector - Choose a dry time by turning the knob to the desired selection. Choose OFF up to MAX LOAD (180 minutes). 'Very Dry' and 'Less Dry' auto dry cycles are available on the WDC7100XC model ONLY. This DRY TIME knob does not move during the dry cycle.

Cycle Selector - Choose a wash cycle or dry cycle by turning the knob to the desired cycle. Each cycle is designed for different types of fabric and soil levels.

Resetting the Controls

Clearing the controls - Pushing and HOLDING the START button for 5 seconds will cancel the current program and allow you to set a new one.

Canceling a cycle in progress and setting a new cycle - Use the START button to cancel a program in progress and start a new cycle:

1. press and HOLD the START button for 5 seconds,
2. select a new cycle, then
3. press the START button and the new cycle will begin.

Description of Cycle Selector Options

Rinse - Use a Rinse cycle to get a rinse and spin only. A Rinse is useful for loads that need rinsing only or for adding fabric softener to a load

Spin - Use the Spin cycle to spin a wet load of laundry at 1200rpm

Drain - Use the Drain cycle to drain the washer-dryer

Description of Option Buttons

You can customize the wash by adding an OPTION or combination of options to your cycle selection. You can add or change the options after starting a cycle anytime before the option begins. (See "Preset Wash/Dry Cycles Chart")

Extra Rinse - Pressing this button will add an extra rinse cycle

Low Spin - Pressing this button will reduce the spin speed to 600 rpm

Low Heat - Pressing this button will reduce the heat temperature during dry

Pre-Wash - Pressing this button will add an extra fill at the beginning of the cycle

Description of Preset Wash Cycles

Cotton Heavy Duty Wash - Use the Cotton Heavy Duty cycles to wash loads of sturdy, colorfast fabrics and normally to heavily soiled garments. These cycles combine fast speed tumbling and an extra high spin speed (1200 RPM) to shorten dry times.

- SUPER - Use this cycle to wash exceptionally soiled cotton garments.
- HEAVY - Use this cycle to wash heavily soiled garments.
- REGULAR - Use this cycle to wash normally soiled garments.
- EXPRESS - Use this cycle to wash smaller loads of lightly soiled garments in less time.

Permanent Press Wash - Use the Permanent Press cycles to wash loads of no-iron fabrics such as sport shirts, blouses, casual business clothes, permanent press blends, linens, and other synthetic fabrics. These cycles combine medium speed tumbling and a high-speed spin (1000 RPM) for reduced wrinkling of synthetic fabrics.

- HEAVY - Use this cycle to wash heavily soiled synthetic fabric garments.
- REGULAR - Use this cycle to wash normally to heavily soiled garments.
- GENTLE - Use this cycle to wash lightly soiled garments.
- EXPRESS - Use this cycle to wash smaller loads of lightly soiled garments in less time.

Delicates Wash - Use the Delicates Cycles to wash sheer fabrics, silk, wool, lingerie and other hand washable items. These cycles combine variable speed tumbling and a low spin speed (800 RPM for WOOL) or Drain ONLY (SILK) for gentle fabric care. (Check the label instructions to make sure that the garment is washable.)

- SILK - Use this cycle to wash silk items, lingerie, and other particularly delicate fabrics.
- WOOL - Use this cycle to clean washable woolen garments and other hand washables.

How to Set a 'Wash ONLY' Cycle:

1. Press the ON/OFF Button to turn the machine power ON (If necessary, press and HOLD the START button to clear the previous cycle)
2. Use the Cycle Selector to select a wash cycle
3. Set the Dry Time knob in the 'OFF' position
4. Press the START Button. The wash cycle will begin.

Description of Preset Dry Cycles

Cotton Dry - Use this high heat cycle to dry sturdy, colorfast fabrics like towels socks and jeans. There's a high spin at the beginning of this cycle to remove more water from fabrics.

Synthetics Dry - Use this medium heat cycle to dry certain blouses and casual business clothes.

Wool Dry - Use this high heat dry cycle to dry wool items ONLY.

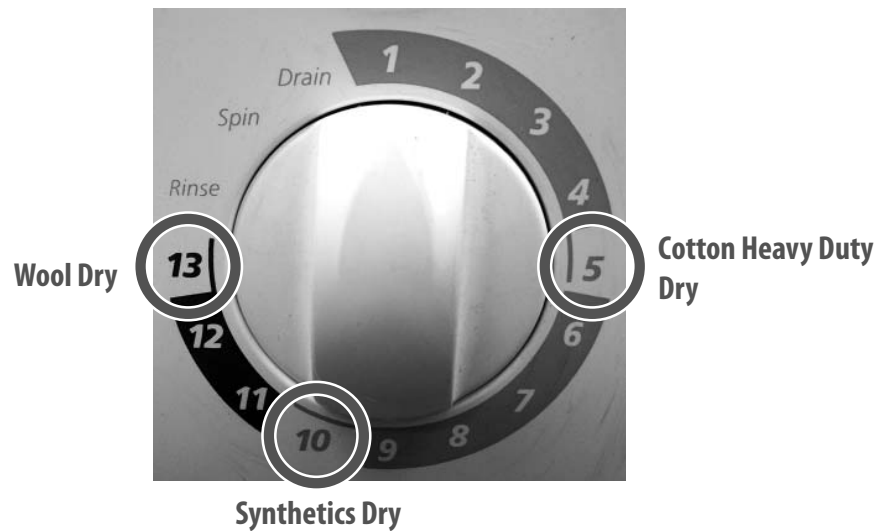

How to Set a 'Wash-to-Dry' cycle

1. Press the ON/OFF Button to turn the machine power ON (If necessary, press and HOLD the START button to clear the previous cycle)
2. Use the Cycle Selector to select a wash cycle
3. Use the Dry Time knob to select the duration of the dry cycle
4. Press the START Button. When the wash cycle is finished, the appropriate dry cycle will begin automatically

How to Set a 'Dry ONLY' cycle

1. Press the ON/OFF Button to turn the machine power ON (If necessary, press and HOLD the START button to clear the previous cycle)
2. Select a Dry Cycle using the Cycle Selector (13, 10, or 5)
3. Use the Dry Time knob to select the duration of the dry cycle
4. Press the START Button. The dry cycle will begin

Preset Wash/Dry Cycles Chart***

Type of fabric	Degree of soil	Program Knob		Detergent		Fabric Softener	Bleach	Special Programs	* Cycle Length	Cycle Description
		No.	Cycle Name	Pre Wash	Wash					
Cotton Heavy Duty Cycles										
Heavy cotton fabrics: i.e. sheets, socks, towels, jeans, underwear, sweatshirts, etc.	Exceptionally Soiled	1	Super		.	.	.	Low Heat Extra Rinse Low Spin	96 min.	Wash cycle, rinse cycles, intermediate and final spin cycles. (1200 RPM High Spin)
	Heavily Soiled	2	Heavy	.	.	.		Low Heat Pre Wash Extra Rinse Low Spin	77 min.	
	Soiled	3	Regular	.	.	.			77 min.	
	Lightly Soiled	4	Express	.	.	.			63 min.	
	-	5	Dry	NOTE: A spin cycle is carried out at the beginning of this dry cycle				Low Heat Low Spin	20 to 180 min.	Spin cycle, timed drying (High Heat)
Permanent Press Cycles										
Synthetic, light cotton and more delicate fabrics: i.e. button-ups, khakis, rayon shirts, etc.	Heavily Soiled	6	Heavy	.	.	.		Low Heat Pre Wash Extra Rinse	66 min.	Wash cycle, rinse cycles, intermediate and final spin cycles. (1000 RPM High Spin)
	Soiled	7	Regular	.	.	.		Low Heat Pre Wash Extra Rinse Low Spin	59 min.	
	Lightly Soiled	8	Light	.	.	.			53 min.	
	Lightly Soiled	9	Express	.	.	.		Low Heat Low Spin	33 min.	
	-	10	Dry	-				Low Heat	20 o 180 min.	Timed drying (Medium Heat)
Delicates Cycles**										
Silk and particularly delicate fabrics	Soiled	11	Silk	Low Heat Pre Wash Extra Rinse	30 min.	Wash cycle, rinse cycles, antcrease or Drain ONLY. (NO Spin)
Wool and Hand Wash fabrics	Soiled	12	Wool	Low Heat Extra Rinse Low Spin	65 min.	Wash cycle, rinse cycles, antcrease or spin cycles. (800 RPM High Spin)
Delicate and lighter fabrics prone to wrinkling	-	13	Dry**	To prevent wrinkles, cycles 11 and 12 will end with the laundry left to soak and the 'Rinse' LED flashing. To finish the cycle, press the START button				Low Heat	20 to 180 min.	Timed drying (High Heat)
About Rinse, Spin and Drain										
<p>* Above cycle lengths may vary according to water pressure, load size and fabric type.</p> <p>** Silk cycle cannot be set to go from 'wash-to-dry' automatically.</p>		Rinse		NOTE: When used, fabric softener is automatically dispensed during the last rinse of each cycle.				Low Heat Extra Rinse	35 min.	Rinse cycles, intermediate and final spin cycles
		Spin		NOTE: High spin speed varies depending on the cycle you choose.				Low Spin	16 min.	Draining and final spin cycle
		Drain		Drains any water from the drum				-	1 to 4 min.	Drain ONLY. NO spin cycle.

NOTE: Some options cannot be added to some cycles.

***Above cycle times will vary according to water pressure, load size and fabric type.

Automatic Routines

The following are routines that the washer-dryer will follow out automatically during all of the wash, spin, rinse and dry cycles.

Door Locking / Unlocking Routines

Door Locking Summary - The Door Locking Routine will only start if the door is securely closed and the Door Switch contact is CLOSED.

1. The Door Switch is energized whenever a cycle is started.
2. During the next few seconds, the contacts on the door switch are checked by the Module Board. The Status/Door Lock light will go SOLID and the cycle will begin.

Door Unlocking Summary - Unlocking will occur ONLY under these conditions:

1. The Main Motor speed equals "0"
2. The water level in the drum does not exceed the door seal
3. The cycle is finished
4. The cycle has been interrupted by following the 'Add-An-Item' instructions below

<p>CHILD DOOR LOCK</p> <p>This washer-dryer is equipped with a Child Door Lock. For your child's safety, the door stays locked for the duration of the WASH and DRY cycles. However, the 'Add-An-Item' feature allows you to unlock the door when needed.</p> <p>NOTE: The 'Add-An-Item' feature is not available whenever it is unsafe to open the door (i.e. during high spins, if water level is to high, etc.)</p>	'Add-An-Item'			
	<table border="1"> <tr> <td style="background-color: black; color: white; text-align: center; vertical-align: middle;">Unlock</td> <td> <ul style="list-style-type: none"> • Press the ON/OFF button; <i>You will hear 2 'clicks' when the door unlocks. It is now safe to open the door.</i> </td> </tr> <tr> <td style="background-color: black; color: white; text-align: center; vertical-align: middle;">Resume</td> <td> <ul style="list-style-type: none"> • Close the door; • press the ON/OFF button to resume the cycle. </td> </tr> </table>	Unlock	<ul style="list-style-type: none"> • Press the ON/OFF button; <i>You will hear 2 'clicks' when the door unlocks. It is now safe to open the door.</i> 	Resume
Unlock	<ul style="list-style-type: none"> • Press the ON/OFF button; <i>You will hear 2 'clicks' when the door unlocks. It is now safe to open the door.</i> 			
Resume	<ul style="list-style-type: none"> • Close the door; • press the ON/OFF button to resume the cycle. 			
<p>IMPORTANT: Never attempt to open the door when the Door Lock LED (D) is LIT SOLID.</p>				

Wash Quality Routines

Drain and Spin Routines - During the Drain and Spin cycles, the water level is checked continuously. Normal Drain and Spin will occur until the Pressure Switch senses no water or foam (suds) in the drum.

Foam Detection and Elimination Routine - Excessive foam can make clothes appear dingy and is usually caused by the use of too much detergent, or the wrong kind of detergent. If the Pressure Switch senses the presence of foam during the Drain or Spin Routine, the Module Board will stop the main motor and the basket will stop spinning. The Drain Pump will turn OFF and the drum will fill with water. Once the tub is filled, the basket will rest for several minutes in an attempt to eliminate the foam before resuming the original cycle. This process will repeat until no foam is detected.

Impulse Spin Technology (IST) - During the Spin cycle the drum will rotate at varying speeds before reaching high spin (instead of a constant pace). This routine optimizes rinse efficiency and drying uniformity - clothing comes out with less creasing and wrinkling.

Automatic Balance Routine

Automatic Balance Routine Summary - An unbalanced load can cause excessive noise and vibration. The Automatic Balance Routine occurs during the distribution ramp (while the basket spin is accelerating from 40 to 600 rpm). At 600 rpm the motor is decelerated and the rate of deceleration is monitored by the Module Board. The motor is then ramped up to 600 rpm and shut off. The rate of deceleration is monitored again and compared to the first deceleration rate. Based on this comparison, the Module Board can determine whether an unbalanced condition exists or not.

- If the Module Board does not sense an unbalanced condition, the ramp will continue.
- If the Module Board senses an unbalance condition, the Main Motor will rotate slowly back and forth for the remainder of the cycle.

NOTES:

Accessing the Components

Component Locations

Follow the instructions in this section to gain access to the following components.

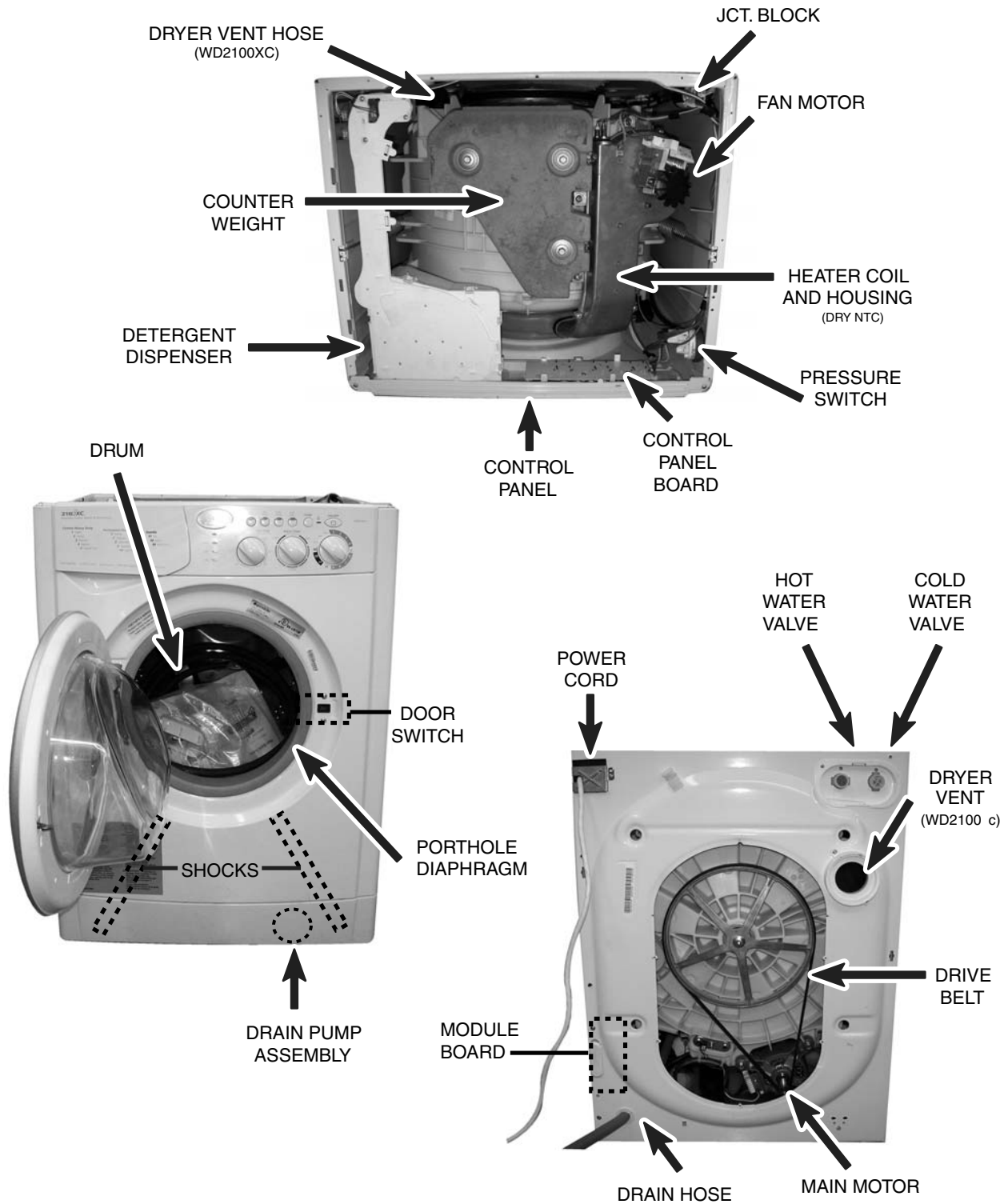

Required Tools

To access components in this washer-dryer, you'll need Metric and Standard sockets of various sizes, Torx-15, 25 Drivers, a Flat Head screwdriver, and a Phillips Head screwdriver.

Top Panel / Control Panel Components

Access to the Control Panel requires that the top of the washer be removed.

Removing the Washer-Dryer Top

Two Phillips Head screws secure the main top at the back of the washer-dryer (Fig. 4-1). Remove these screws and lift straight up on the rear of the main top.



Fig. 4-1

Removing the Knobs

Remove the knob by pulling straight out. If you need to use pliers, make sure to use a shop rag as a buffer, so the knob does not get damaged.

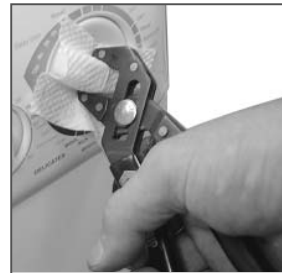

Removing the Control Panel Board

1. Remove the wire connector from the panel board (Fig. 4-2).
2. Remove the two Phillips screws that secure the panel board to the control panel (Fig. 4-2).
3. Gently lift up on tabs on the back of the control panel board (Fig. 4-2) and push in the tabs on the selector knob shafts (Fig. 4-3) and pull out panel board using care not to break the tabs.

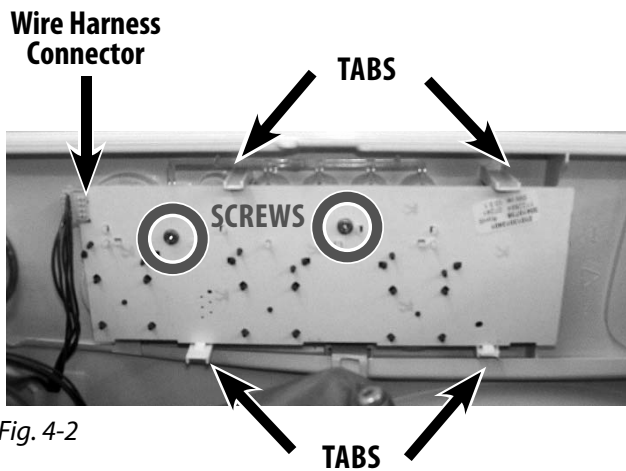

Fig. 4-2

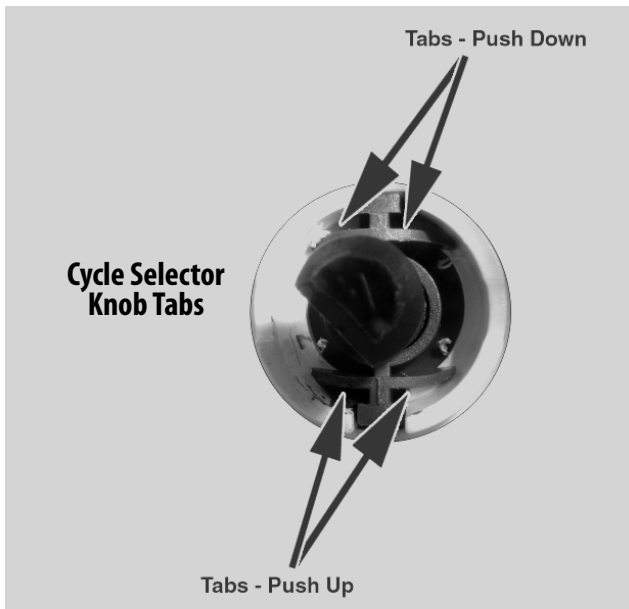

Fig. 4-3

Removing the Control Panel

1. Remove the three Phillips Head Screws (Fig. 4-4) located behind the Dispenser Drawer
2. Remove the two Philips Head Screws located on the top corners of the Control Panel (Fig. 4-5) and then lift the entire panel straight off.



Fig. 4-4

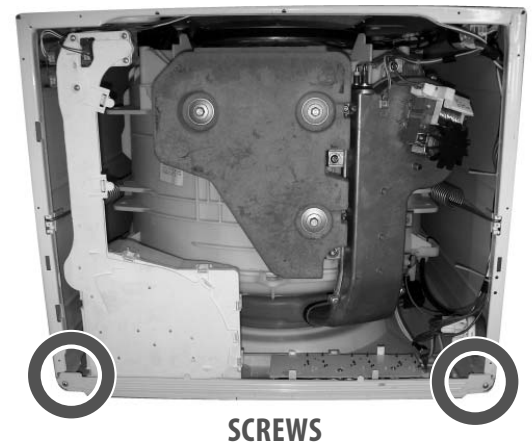

Fig. 4-5

Door / Door Switch / Porthole Diaphragm

Open the Door to access the Door, Door Switch and Porthole Diaphragm.

Removing the Door

Remove the two, size 15 Torx screws that secure the door to the door hinge. (Fig. 4-6)



Fig. 4-6

Removing the Door Switch

If the top cannot be removed, access to the door switch requires that the porthole diaphragm be eased back from the front of the washer. To do this, locate the retainer spring and use a small tool to grab the hoop in the spring. (Fig. 4-7) Pull the retainer forward and then off the perimeter of the diaphragm.



Fig. 4-7

Retainer
Spring
Loop

Ease the edge of the diaphragm off of the lip of the washer front near the door switch. (Fig. 4-8) Remove enough of the diaphragm to gain access to the door switch behind the washer dryer front



Fig. 4-8

panel. (See "Removing the Porthole Diaphragm" to remove the entire diaphragm.) The door switch is secured to the washer front panel with two, size 15 Torx screws. (Fig. 4-9) Once these screws are removed, the door switch will remain in place until it is lifted slightly and pulled back from the washer panel. Then, remove the wire plug from the door switch.

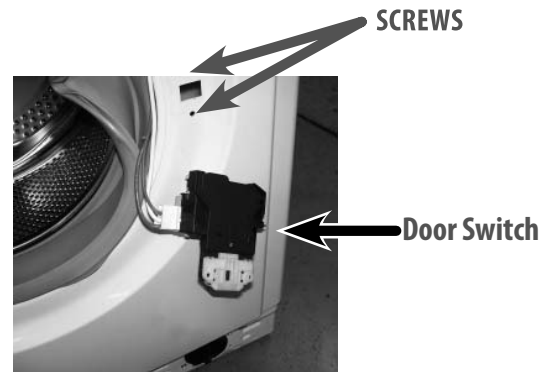

Fig. 4-9

Removing the Porthole Diaphragm

The porthole diaphragm can be completely removed from the outer rim of the tub assembly. Locate and remove the large sprig that holds the porthole to the drum (Fig. 4-10). Pull the diaphragm off the drum and out of the machine.

Note: The Heater Housing and Coil enter the boot at the 1 o'clock position. Use care not to damage the diaphragm.



Fig. 4-10

Detergent Dispenser Assembly / Water Valves

Access to the Detergent Dispenser and Water Valves requires that the top of the washer be removed.

Removing the Dispenser Assembly

Begin by removing the top, then use two hands to pull the dispenser drawer completely out of the housing. (Below)



Remove the three Phillips Head screws securing the front of the detergent dispenser assembly to the front of the Control Panel. (Fig. 4-11) Remove the two screws securing the detergent dispenser assembly to the dispenser valves. (Fig. 4-12) Disconnect the two wires from the hot valve.



Fig. 4-11



Fig. 4-12

Disconnect the dispenser hose from the detergent dispenser assembly by pulling the loop on the hose off to the side of the assembly. (Fig. 4-13) Once that is removed, the hose can be pulled straight off. Now you can lift the detergent dispenser assembly out.

IMPORTANT!

Be sure to reattach the hose correctly, or it will vibrate off of the bottom of the housing and the unit will leak water.

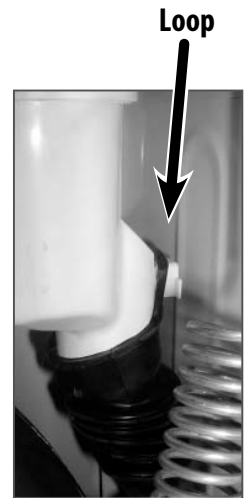

Fig. 4-13

Removing the Water Valves

When the Detergent Dispenser Assembly is removed, the water valves will be exposed. Make sure the water valve seals are correctly installed on the water valves before re-assembly. (Fig. 4-14) Remove the two screws that secure the valves to the back of the machine. (Fig. 4-15, next page)

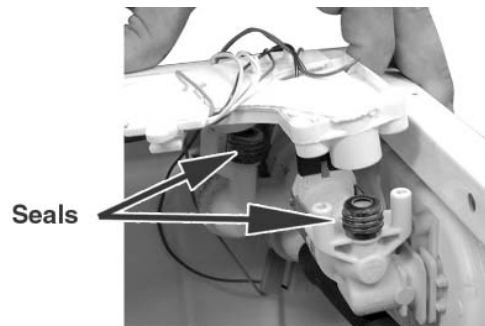

Fig. 4-14

IMPORTANT!

It's very important to note the orientation of the wiring on the valves for re-installation. If the wiring is switched the water temperatures will be incorrect, and on condenser machines, the dry cycle will not operate correctly.



Fig. 4-15

Pressure Switch

The Pressure Switch is located on the top-right, front corner of the machine. The pressure switch can be accessed once the top is removed.

Removing the Pressure Switch

Using pliers, squeeze the clamp to disconnect the black hose from the bottom of the pressure switch. (Fig. 4-16) Be careful not to pull up on the hose too much, or it may become disconnected from the bottom of the drum.

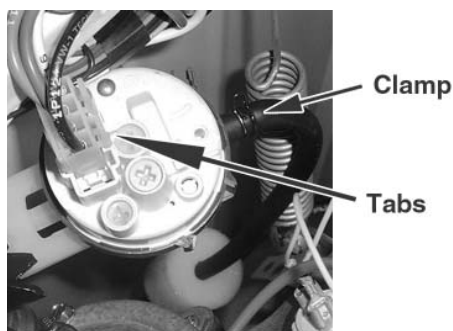

Fig. 4-16

Next, squeeze the tabs (Fig. 4-16) to remove the wiring harness connectors from the pressure switch. Be sure to check the wire connector for a tight connection after re-installation. Gently wiggle the switch back and forth while pulling out to remove the switch from the cabinet (Fig. 4-17).

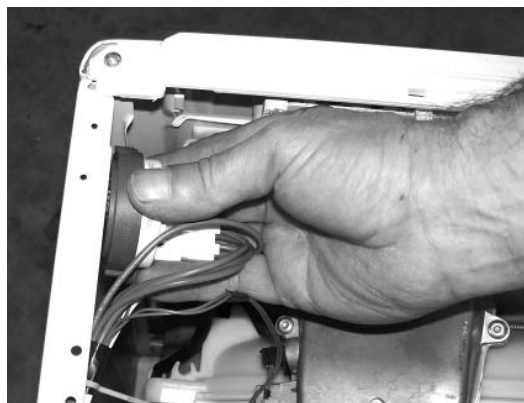

Fig. 4-17

Fan Motor, NTC Sensor and Heater Coil

The Fan Motor, NTC Sensor, Heater Coil and Housing sit on the drum and are located on the top, right side of the machine. It can be accessed once the top is removed.

Removing the Fan Motor

Disconnect the two wires that are attached to the fan motor and the ground wire attached to the housing (Fig. 4-18). Next, remove the six 15 torx head screws that secure the two halves of the heater housing. Lift the top of the housing straight off and turn it over.

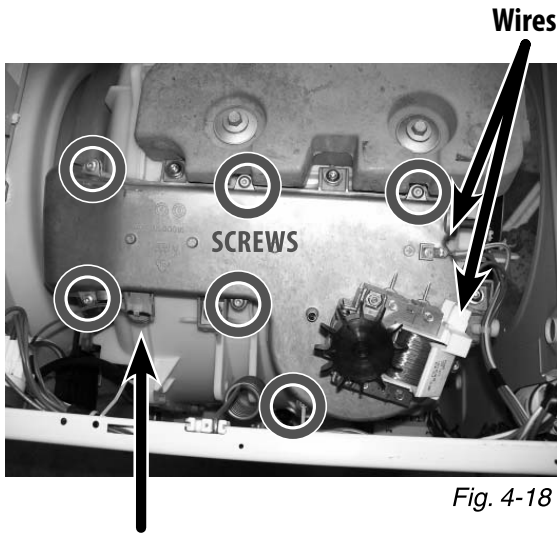

Fig. 4-18

Remove the 10mm nut with LEFT-HANDED threads (Below) that secures the impeller to the motor shaft. Lift the impeller straight off the fan motor shaft. You may need to use a punch. **NOTE: Make sure the impeller does not touch the gasket when re-installed. If the gasket is damaged it will need to be replaced.**

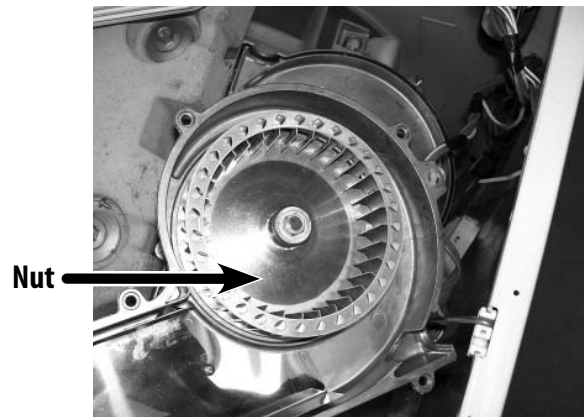

Fig. 4-19

Removing the NTC Sensor

Lift the NTC Sensor from the heater housing (Fig. 4-8). Remove the Wire Harness Connector from the sensor. **NOTE: When reinstalling the sensor, make sure the plastic housing is lined up with the duct assembly.**

Removing the Heater Coil

Remove the two wires from the heater coil and lift the heater coil out of the heater housing.



Fig. 4-20

Heater Coil

Lower Panel / Drain Pump / Pump Filter

*The Drain Pump is located at the lower, right-corner of the machine.
You'll need to remove the Lower Panel to access the Drain Pump and Pump Filter.*

Removing the Lower Panel

Gently ease down the top of the panel with a flat blade screwdriver or plastic putty knife.

Remove the panel by lifting slightly and pulling forward. (Below)

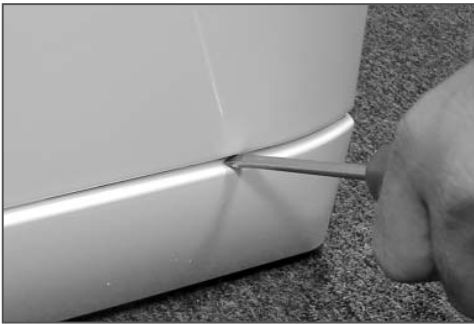

Removing the Drain Pump

With the Lower Panel removed and any residual water drained from the unit, gently tip the washer onto its' left side.

Remove the 4 screws that secure the sheet metal cover to the bottom of the washer. (Below) Remove the metal cover.

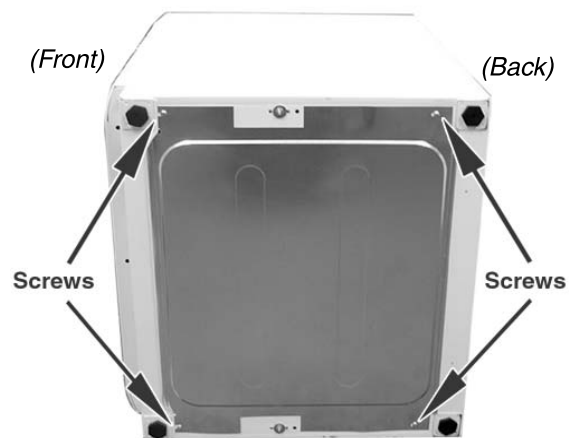

Remove the two screws that secure the pump to the cabinet. (Fig. 4-23) Rotate the pump clockwise from inside the unit and then pull to remove it from the cabinet.

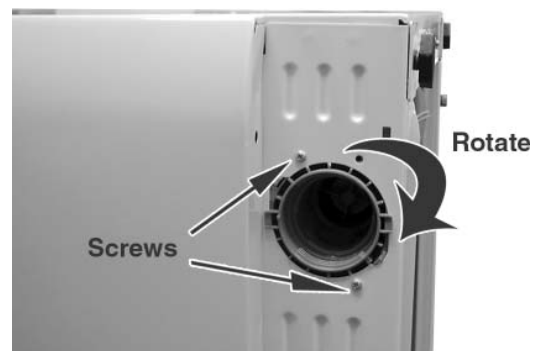

Fig. 4-23

(Continued on the next page)

Before you disconnect the hoses, note their orientation and place a towel under them to catch any water left inside. Unclamp the hoses from the drain pump and remove the pump assembly. (Fig. 4-24)

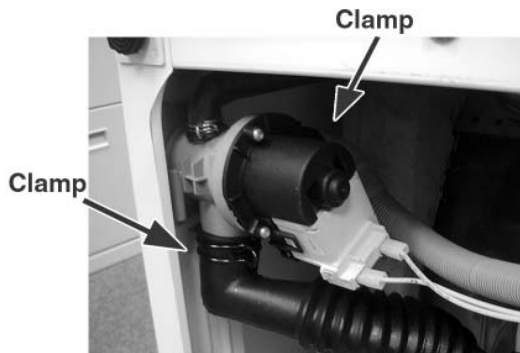

Fig. 4-24

To Clean Out the Large Item Filter

To clean out the Large Item Filter, turn the large knob counterclockwise and pull it out. (Below) Place a small pan or towel under the pump prior to removing the large item filter. There WILL be water in the pump housing.



Back Panel / Main Motor / Module Board

The Main Motor and Module Board can be accessed once the back panel has been removed.

Removing the Back Panel

Remove the 7 Phillips screws that secure the panel to the back of the cabinet. (Below) Now lift the panel off.

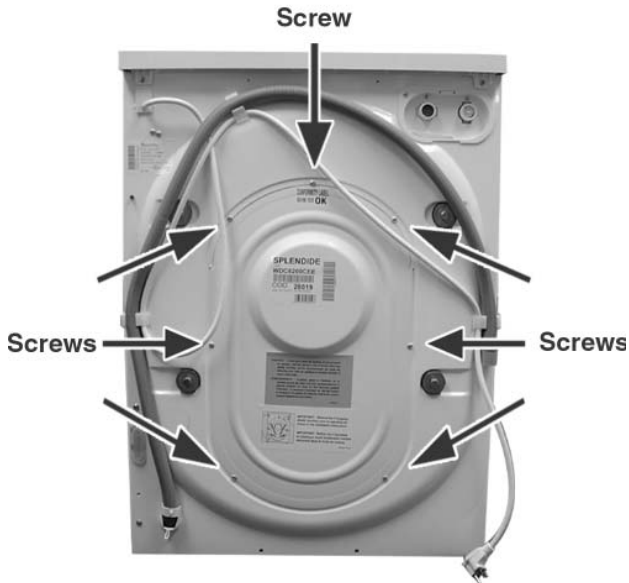

Removing the Module Board

Remove the two, size 15 Torx Head screws that secure the Module Board to the case (below).



Gently tip the unit on its left side (looking from the back). Next, take the wires out of the retainers on the Module Board Housing (Fig. 4-26). Note all wire connections, then remove the wire connectors from the module board and lift the board out of the unit.

Removing the Main Motor

After removing the back panel, remove the Drive Belt. Next, remove the two 13mm mounting bolts that secure the motor to the tub. (Fig. 4-25) Slide the motor out of the unit.

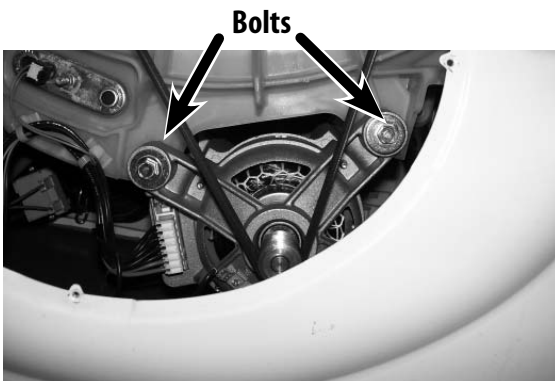

Fig. 4-25

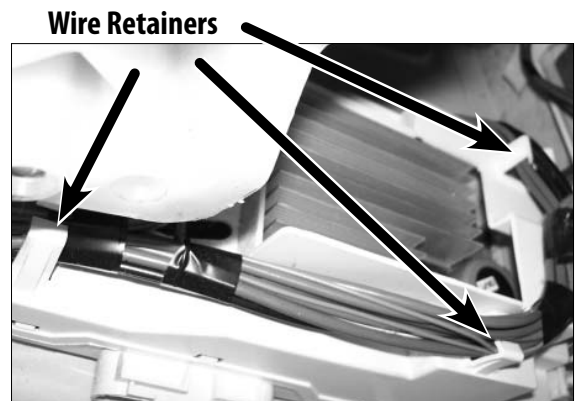

Fig. 4-26

IMPORTANT!

When re-installing the Main Motor, it's very important to make sure that it's properly re-seated and aligned, with the hangers lined up with the back side of the motor.

Shock Absorbers

The Shock Absorbers can be accessed once the bottom panel has been removed.

Removing the Bottom Panel

The tub is held in position by two shock absorbers. To access the Shock Absorbers, First, place the washer-dryer on its left side.

Remove the 4 screws that secure the sheet metal cover to the bottom of the washer. (Below) Now, remove the metal cover.

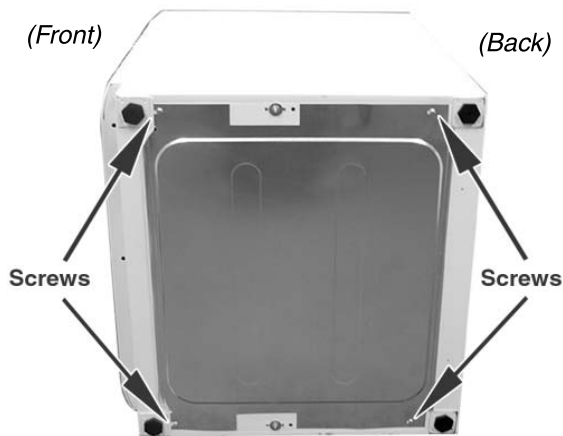

Removing the Shock Absorbers

Remove the bolts that secure the shock absorbers to the tub using a 12mm, 15mm or 13mm socket (depending on serial number).

Remove the plastic plugs that secure the shock absorbers to the bottom of the case using needle nose pliers. (Fig. 4-27)

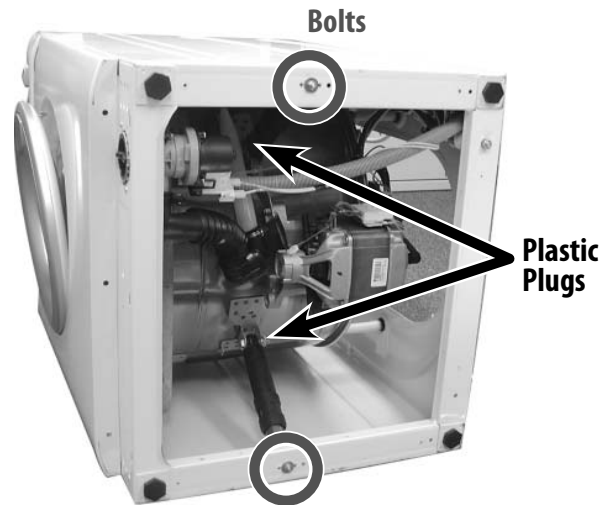
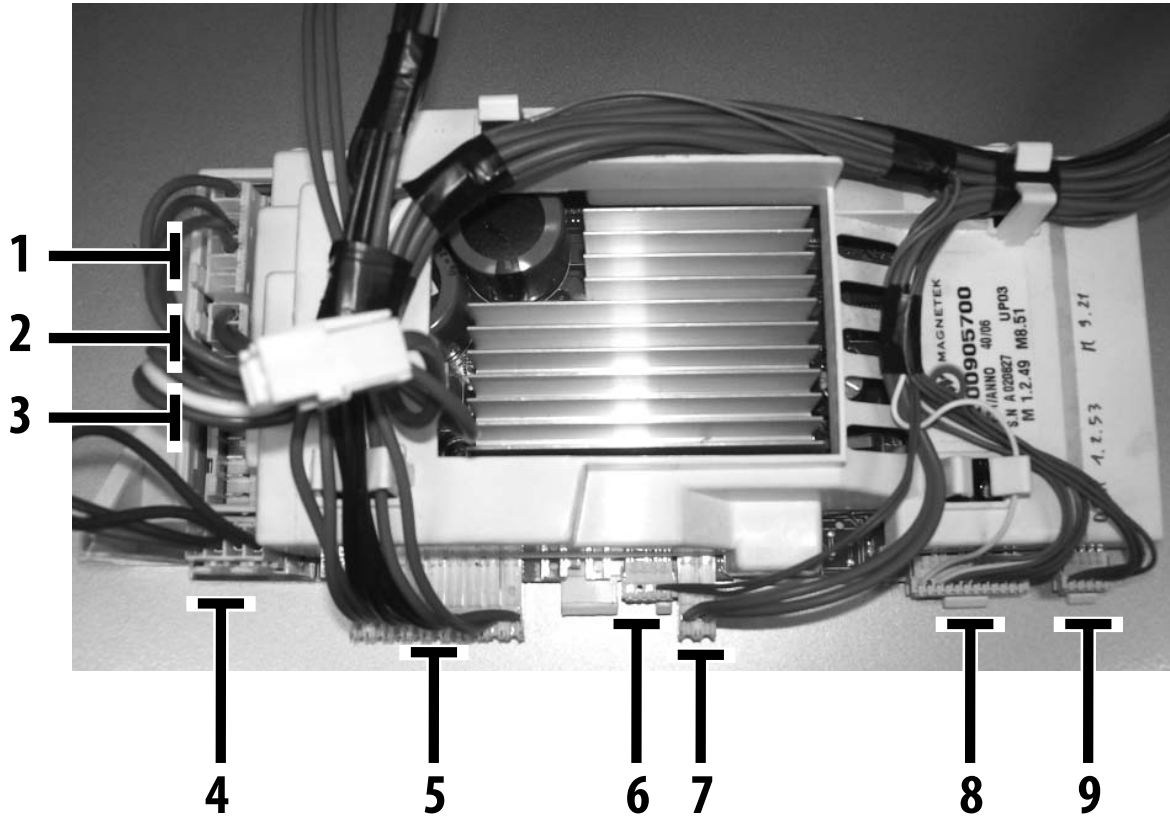

Fig. 4-27

Component Testing Procedures

Connector Locations on the Module Board

The following tests are performed by taking ohm readings on the Module Board connections listed below. The Module Board can be accessed once the back panel has been removed. See "Component Access Locations."



COMPONENT	CONNECTOR	FAULT CODE(S)*
1 Pressure Switch	J3	F04, F05, F07, F08, F10, F15
2 Heating Element	J2	F14, F15
3 Door Switch	J4	F17
4 Power in from Surge Protector	J1	N/A
5 Main Motor and Waer Pump	J9	F01, F02, F11
6 Dry NTC Sensor / Condenser Valve **	J10	F13, F14
7 Fan Motor	J16	N/A
8 Water Valves/Wash NTC	J8	F03
9 Control Panel Board	J11	F12

* For more information about how to read Fault Codes and what they mean, see the "Fault Code Chart"

(Continued on the next page)

** Condenser Valve ONLY on WDC7100XC

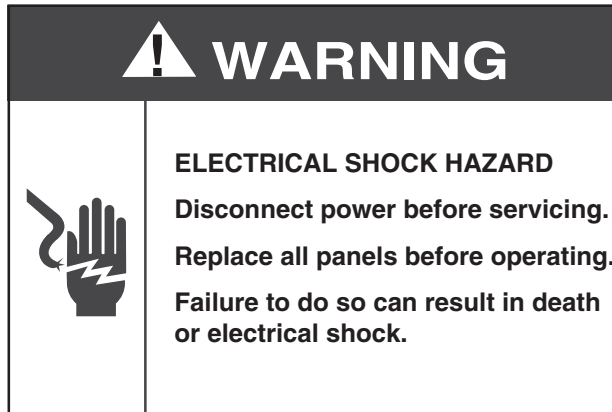

Introduction

Before testing the components, ALWAYS:

- Make sure that the power cord is firmly plugged into a live circuit with the proper voltage.
- Check for a blown household fuse or circuit breaker that has tripped.
- Make sure that the dryer vent is properly installed and clear of lint obstructions. (WD2100XC Only.)

When testing, follow these instructions:

- Resistance tests **MUST** be made with the power cord unplugged from the outlet, and the wire connector removed from the Module Board.
- All tests should be made with a VOM (volt ohmmeter) or DVM (digital volt ohmmeter) having a sensitivity of 20,000 ohms-per-volt DC or greater.
- **BEFORE** replacing any component, **ALWAYS** check for wire connectors that are not pressed tightly into their terminals. Tests **MUST** be made with **ALL** connectors attached. Look for broken or loose wires, failed terminals, or wires that are not pressed into their connectors far enough.

Your Test Results

If the readings you obtain with the following tests match the specified range, the tested component is operating correctly.

If the readings you obtain are not in the specified range, call Splendide Service at 1-800-356-0766 (503-655-2563) ext. 5 for further assistance. **Have the Model and Serial Number of your machine ready when you call.**

1. Door Switch Testing

Door Switch Test Points are located on the connector on the Module Board and on the Door Switch
(See "Connector Locations on the Module Board")

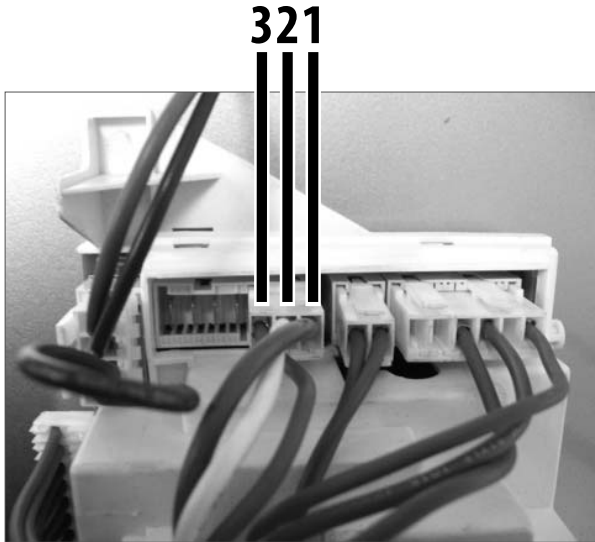

J4 on Module Board

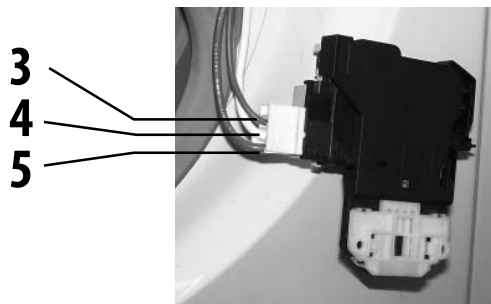

Door Switch

Fault Codes: F17

	Test Points	Reading
Door Switch to J4	3 to 3	0 ohms
Door Switch to J4	4 to 2	0 ohms
Door Switch to J4	5 to 1	0 ohms

2. Power “in” from the Surge Protector Test

Surge Protector Test Points are located on both the Surge Protector and on the J1 Connector. The Surge protector is connected to the Module Board (See “Connector Locations on the Module Board”). The J1 Connector is on the Module Board (See “Connector Locations on the Module Board”)

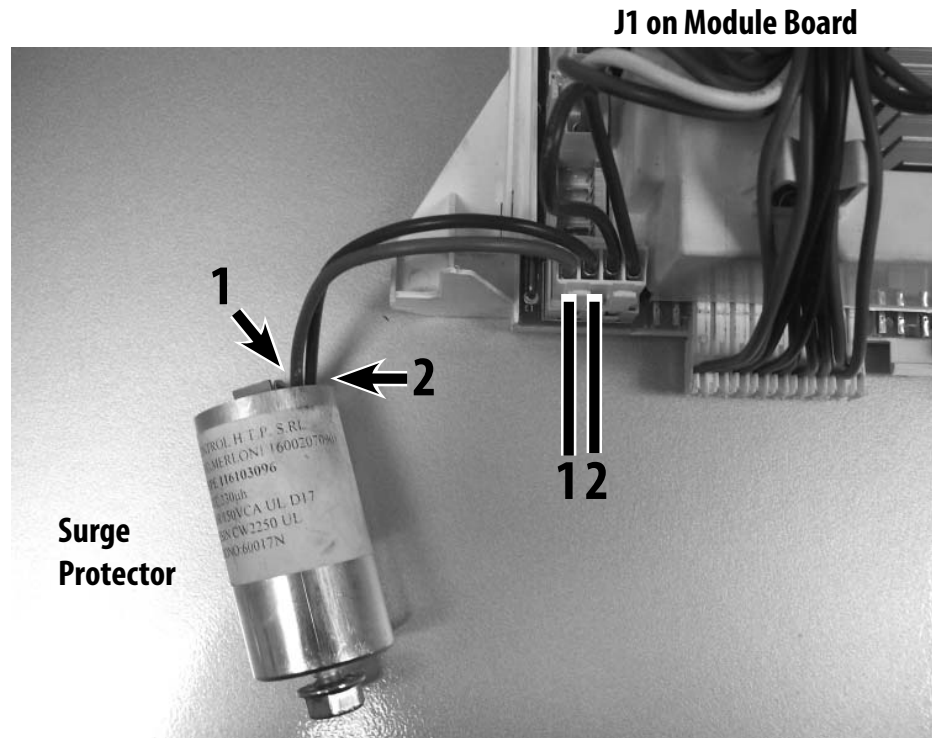

Fault Codes: N/A

	Test Points	Reading
Surge Protector to J1	1 to 1	0 ohms
Surge Protector to J1	2 to 2	1.0 ohms

3. Pressure Switch Test

Pressure Switch Test Points are located on both the J3 Connector and on the Pressure Switch. The J3 Connector is on the Module Board (See "Connector Locations on the Module Board"). The Pressure Switch can be accessed once the top is removed (See "Component Access Locations")

Switch

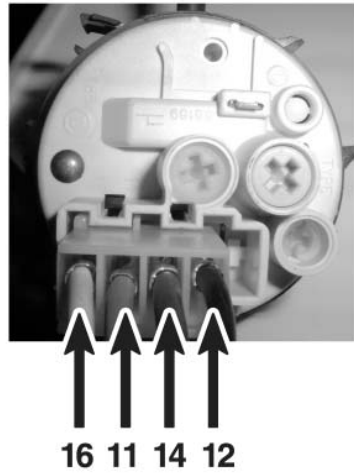

J3 on the Module Board

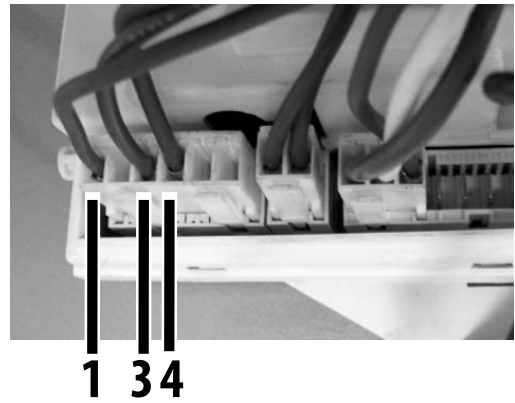

Fault Codes: F04, F05, F07, F08, F10, F15

	Test Points	Reading
Water Level Empty	11 to 12	0 ohms
Water Level Full	11 to 14	0 ohms
Water Level Overfull	11 to 16	0 ohms

	Test Points	Reading
J3 to Switch	1 to 16	0 ohms
J3 to Switch	3 to 14	0 ohms
J3 to Switch	4 to 12	0 ohms

4. Heating Element Test

Heating Element Test Points are located on the J2 Connector on the Module Board
(See "Connector Locations on the Module Board")

J2 on the Module Board

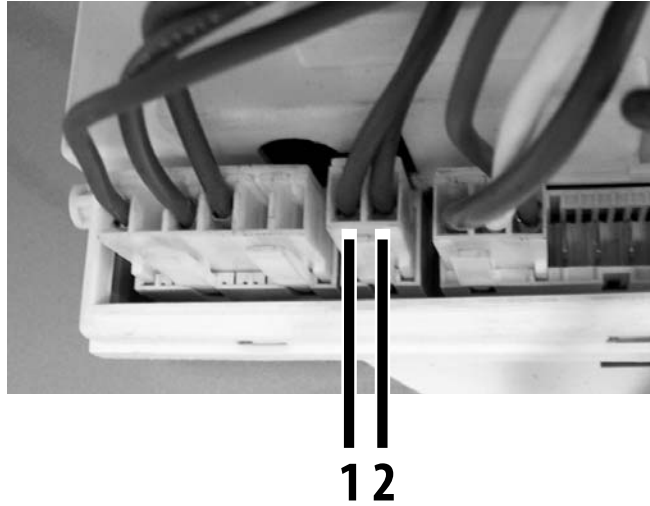

Fault Codes: F17

	Test Points	Reading
J2 Connector	1 to 2	11 ohms

5. Main Motor and Water Pump Test

Main Motor Test Points are located on the J9 Connector on the Module Board
(See "Connector Locations on the Module Board").

J9 on the Module Board

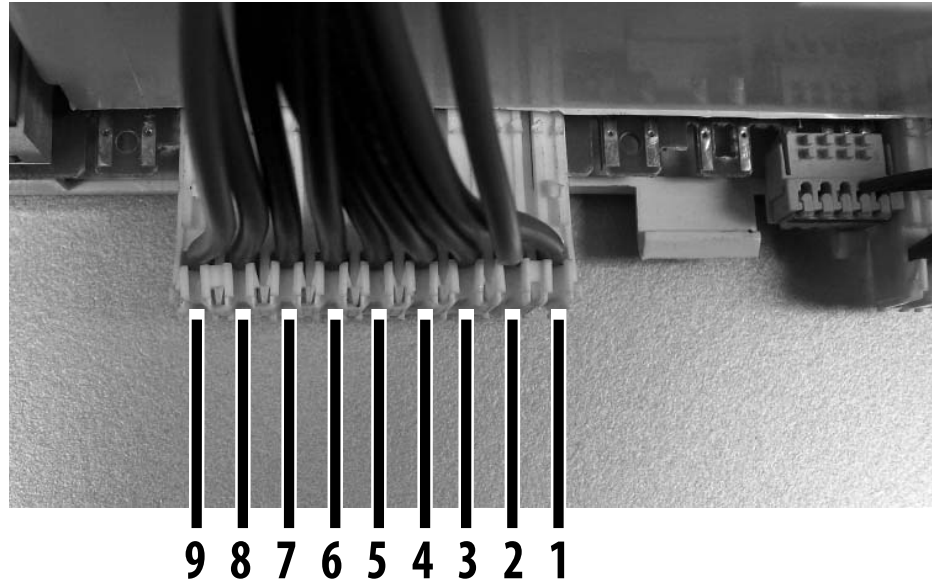

Fault Codes: F11

	Test Points	Reading
Pump	8 to 9	22.5 ohms

Fault Codes: F01, F02

	Test Points	Reading
Motor Protector	7 to 6	0 ohms
Stator	5 to 4	9.9 ohms
Stator	5 to 3	9.9 ohms
Stator	3 to 4	9.9 ohms
Tachometer	1 to 2	180 ohms

Running the Main Motor with AC Voltage Test:

Connect AC cord to pins 5 and 3 (motor should run), then 5 and 4 (motor should run), then 3 and 4 (motor should run). If the motor does not run on any combination, then the motor is bad.

6. Fan Motor Test / Water Valve for WDC7100XC Test

Fan Motor Test Points are located on the J16 connector on the Module Board
(See "Connector Locations on the Module Board")

J16 on the Module Board

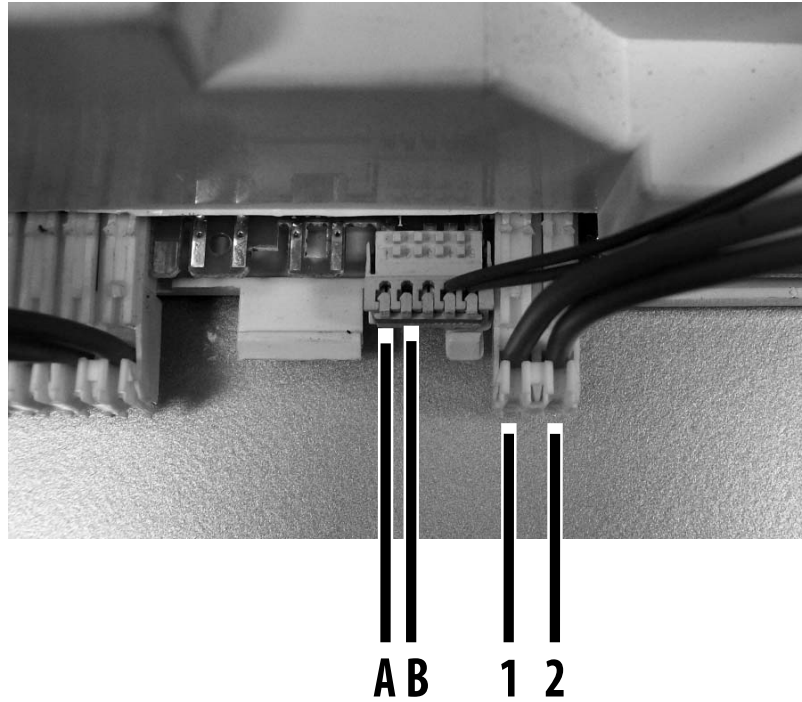

Fault Codes: N/A

	Test Points	Reading
J16 Connector (Fan Motor)	1 to 2	10 ohms
Condenser Valve*	A to B	1000 ohms

* Condenser Valve ONLY on WDC7100XC

7. Water Valve Test / Wash NTC Test

Water Valve Test Points are located on the J8 Connector on the Module Board
(See "Connector Locations on the Module Board")

J8 on Module Board

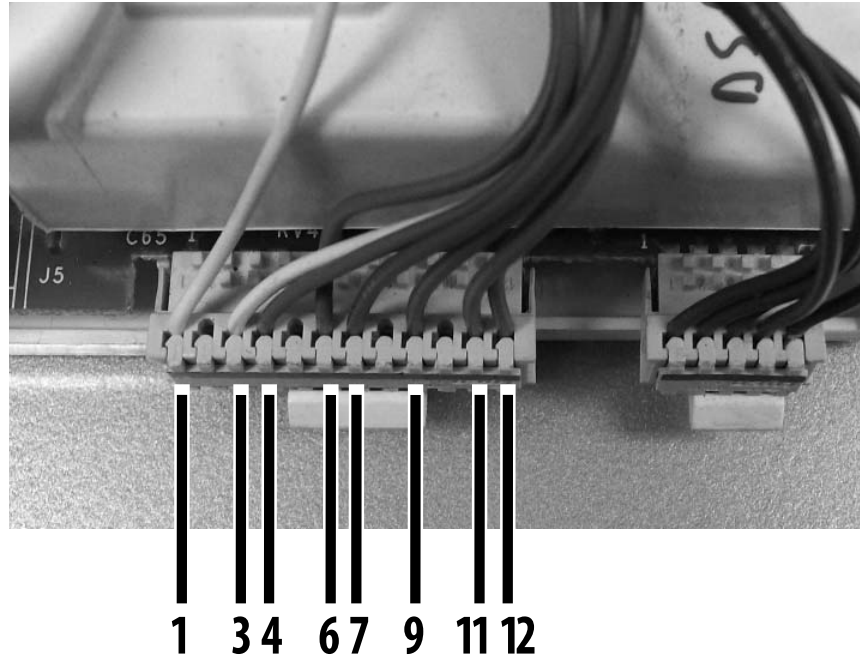

Fault Codes: F3 (Wash NTC)

	Test Points	Reading
Cold Valve	1 to 3	1,000 ohms
Cold Softener	4 to 6	1,000 ohms
Hot Valve	7 to 9	1,000 ohms
Wash NTC	11 to 12	20,000 ohms
Condenser Valve* Test see page 46		

* Condenser Valve ONLY on WDC7100XC

8. Control Panel Board Test

Control Panel Board test points are located on the control panel board and the J11 connector of the Module Board
(See "Connector Locations on the Module Board")

J11 on Module Board

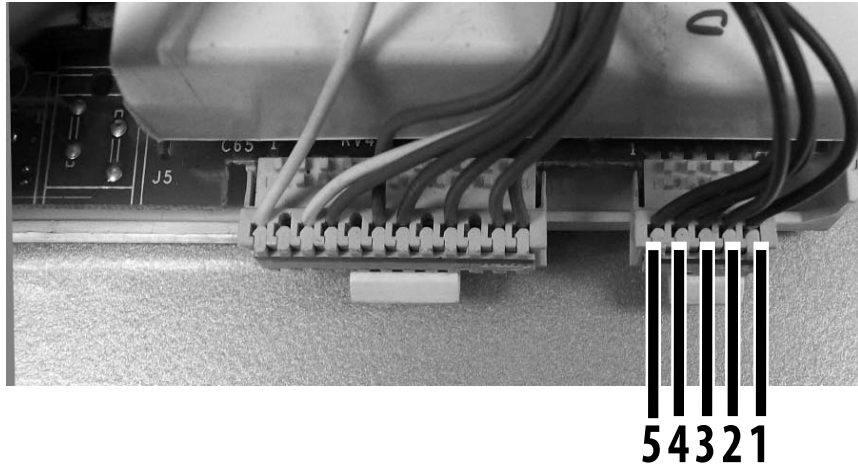

J11 on Module Board

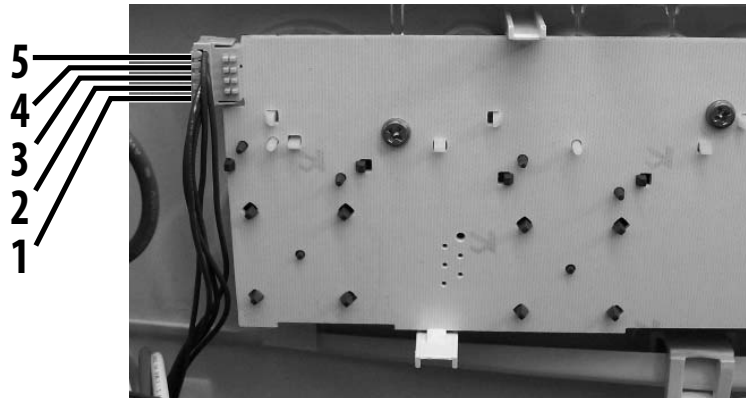

Fault Codes: F12

	Test Points	Reading
J11 to Control Panel Board	1 to 5	0 ohms
J11 to Control Panel Board	2 to 4	0 ohms
J11 to Control Panel Board	3 to 3	0 ohms
J11 to Control Panel Board	4 to 2	0 ohms
J11 to Control Panel Board	5 to 1	0 ohms

9. Dry NTC Sensor Test

NTC Sensor Test Points are located on the J10 Connector on the Module Board

J10 on the Module Board

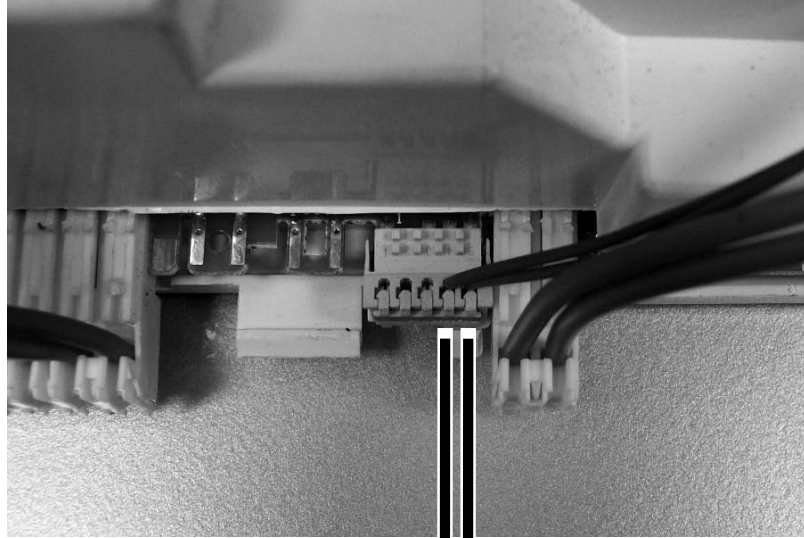

45

Fault Codes: F13

	Test Points	Reading
J10 Connector	4 to 5	27K@65°F

Diagnosis & Troubleshooting

Introduction

This section includes an Explanation of the Fault Codes for models WD2100XC and WDC7100XC as well as a Fault Code/Testing Procedure Chart and a Problem/Testing Procedure Chart.

Time-Saving Tech Tips are included at the end of the chapter. **Contact Westland Sales for a complete list of Service Bulletins and updates for these models.**



Control Panel Fault Code Display, Fig. 6-1

Explanation of Fault Codes

These appliances incorporate an onboard diagnostic system to help you troubleshoot any problems that you may encounter. (See Chart on next page.) **When the machine is in the Fault Mode,**

- The DOOR LOCK LED will flash quickly (frequency > 1 Hz, flashes more than one time per second)
- An LED or combination of LED's will light on the Control Panel (see Fig. 6-1 on opposite page).

After identifying the Fault Code, see chart on next page for further testing procedure(s).

	LED ON
	LED OFF

FAULT CODE	CAUSES	LED COMBINATION				
		LED A	LED 1	LED 2	LED 3	LED 4
F01	Motor triac short-circuit					
F02	Motor blocked, tacho open / short-circuited					
F03	Wash NTC sensor open / short-circuited					
F04	Empty + pressure switch overflow simultaneously					
F05	Empty pressure switch not reached Drain pump blocked					
F06	Selector code not found					
F07	No absorption of wash heater					
F08	Contact NA/NC of the wash heater relay welded					
F09	Setup file error (EEPROM not Programmed or damaged)					
F10	No signal of simultaneous empty and full					
F11	Drain pump not supplied					
F12	No communication between Control Panel Board and Main Board					
F13	Drying NTC sensor open / short circuited. Fan motor blocked					
F14	No absorption of drying heater					
F15	Contact of drying heater relay welded					
F16	Drum lock (top-loading only)					
F17	Door lock not supplied / open					
F18	Error in communication between Micro Processor and DSP (Digital Signal Processor)					

Fault Code / Testing Procedure Chart

See "Explanation of the Fault Codes" on the previous page to determine the Fault Code that the washer-dryer is displaying. Then, follow the recommended testing procedure to troubleshoot the problem. Call Westland Sales if the machine continues displaying the Fault Code.

Fault Code	Explanation / Recommended Testing Procedure
F01	Short-circuited Motor TRIAC on Module Board <ul style="list-style-type: none"> • Verify Drive Motor connections and wiring. See "Component Testing". • Open the door of the washer-dryer and verify the drum spins freely and is not hitting anything.
F02	Blocked Motor/Tachometer Open/Short-Circuited <ul style="list-style-type: none"> • Verify Drive Motor connections and wiring. See "Component Testing". • Verify motor operation. Refer to "Test Running the Main Motor with AC Voltage" pg 47. • Open the door of the washer-dryer and verify the drum spins freely and is not hitting anything.
F03	Wash NTC Sensor Open/Short-Circuit <ul style="list-style-type: none"> • Verify NTC Connections and wiring. See "Component Testing".
F04	Both Empty and Over Flow Signals Present <ul style="list-style-type: none"> • Verify Pressure Switch connections and wiring. See "Component Testing".
F05	Blocked Pump/Pressure Switch Stuck on Empty <ul style="list-style-type: none"> • Check Pump Pre-Chamber for blockage. See "Component Access". • Verify pump connector and wiring. See "Component Testing". • Verify Pressure Switch connections and wiring. See "Component Testing".
F06	Selector Binary Code Not Found <ul style="list-style-type: none"> • Verify Program Selector connections and wiring, See "Component Testing".
F07	<i>Not Applicable</i>
F08	<i>Not Applicable</i>

Fault Code	Explanation / Recommended Testing Procedure
F09	File Set-Up Error (Unverifiable Fault)
F10	Missing or Conflicting Pressure Switch Signal <ul style="list-style-type: none"> • Verify Pressure Switch connections and wiring. See “Component Testing”.
F11	Drain Pump Power Supply Failure <ul style="list-style-type: none"> • Verify Drain Pump connections and wiring, See “Component Testing”.
F12	Communication Failure <ul style="list-style-type: none"> • Verify Module Board connections and wiring. See “Component Testing”.
F13	Dry NTC Sensor Open/Shorted Circuit <ul style="list-style-type: none"> • Verify NTC Sensor connections and wiring. See “Component Testing”. • Verify the fan motor is not stuck, obstructed, or open. See “Component Access”.
F14	Dryer Element on, Pressure Switch Sensing Water in Drum <ul style="list-style-type: none"> • Verify pressure switch connector and wiring. See “Component Testing”.
F15	Dry Heating Element Relay Malfunction <ul style="list-style-type: none"> • Verify Heating Element connections and wiring. See “Component Testing”.
F16	<i>Not Applicable</i>
F17	Door Lock not Supplied <ul style="list-style-type: none"> • Verify Door Switch connections and wiring. See “Component Testing”.
F18	Error in Communication between microprocessor and DSP <ul style="list-style-type: none"> • Replace Module Board.

Problem / Testing Procedure Chart

Follow these steps in the order they are listed to effectively troubleshoot the problem.
Call Westland Sales if the problem continues after you have completed the recommended tests.

Problem	Testing Procedure
WON'T POWER UP	<ol style="list-style-type: none"> 1. Check the line voltage for blown fuses. 2. Check for voltage going to the Module Board. 3. Before continuing, unplug the unit. 4. Check continuity of line cord and line filter. 5. Remove the washer-dryer back and check wire harness connections to the Module Board. 6. Check for correct wiring at the surge protector.
WON'T START CYCLE	<ol style="list-style-type: none"> 1. Open and close the door. 2. Verify there is water entering the Hot and Cold Valves. 3. Check the Door Switch using the Component Testing procedure. 4. If door is locked, select "Drain" on the Cycle Selector to drain the drum. 5. Remove the washer-dryer top and check the wire harness connections.
WON'T DISPENSE LAUNDRY AIDS	<ol style="list-style-type: none"> 1. Verify the unit is level. 2. Verify the Dispenser Drawer is not clogged with detergent. 3. Check water connections to the unit. Check for plugged water valve screen. 4. Remove the top and check water connections within the unit.
WON'T FILL	<ol style="list-style-type: none"> 1. Check installation. 2. Check inlet valves. 3. Check water connections to the unit. Check for plugged water valve screen. 4. Remove the top and check water connections within the unit.
CYCLE SELECTOR ROTATES ON IT'S OWN	<ol style="list-style-type: none"> 1. Move the Cycle Selector knob to any position except a 'Reset' and the washer will return to the original cycle. 2. Check to see if the unit is displaying Fault Code (See "Explanation of the Fault Codes")
OVERFILLS	<ol style="list-style-type: none"> 1. Verify the unit is level. 2. Check Pump Drain system - this could indicate a failure to drain. 3. Check Operating Pressure Switch. 4. Check Pressure Switch hose for holes, cut marks. 6. Check the Module Board.

Problem	Possible Cause / Recommended Testing
DRUM WON'T ROTATE	<ol style="list-style-type: none"> 1. Remove the washer-dryer back and check the Drive Belt. 2. Check the Main Motor. 3. Check the Wire Harness connections.
WON'T DRAIN	<ol style="list-style-type: none"> 1. Remove the washer-dryer back and check the Drain Pump 2. Check that the Drain Hose and Large Item Filter is clear of foreign objects. 3. Check the Module Board.
MACHINE VIBRATES	<ol style="list-style-type: none"> 1. Verify the Transit Screws/Spacers have been removed. 2. Check the Installation. 3. Check the Leveling Feet. 4. Check for a weak floor. DO NOT install on carpet. <p>NOTE: Some vibration is normal.</p>
INCORRECT WATER TEMPERATURE	<ol style="list-style-type: none"> 1. Check that the Inlet Hoses are connected properly. 2. Remove the washer-dryer top and check the wiring to the Dry Time and Water Temperature Selectors to make sure they aren't reversed.
WON'T DRY	<ol style="list-style-type: none"> 1. Check the dry cycle and load size. If testing with the drum empty, use Permanent Press Dry ONLY. 3. Verify that the Fan Motor is rotating. If it is, go to Step 4. If not, try rotating it by hand. If you can't rotate it by hand, check for 110V AC across the two wires. If voltage is present, but the fan will not rotate, the Fan Motor will need to be replaced. 4. Perform a "Dryer Airflow and Heat Test" (See pg. 56)

Tech Tips

Manually Unlocking the Door

1. Unplug the power cord from the outlet.
2. Remove the Lower Panel.
3. Unclip the Door Switch Release Cable from the cabinet of the unit.
4. While pulling downward on the Door Switch Release Cable, open the door with the door handle. **If you still cannot open the door, Contact Splendide Technical Service.**

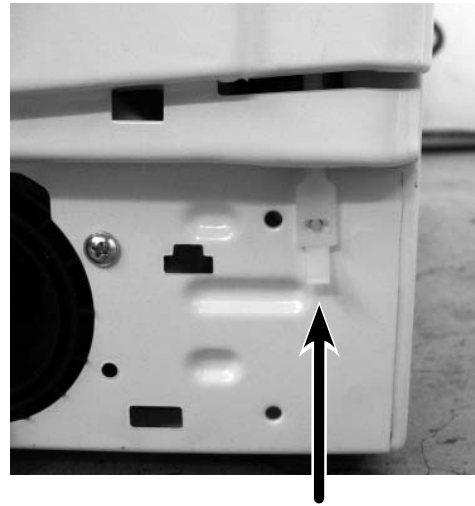

**Door Switch
Cable**

Performing a Dryer Airflow & Heat Test

1. Open the door.
2. Set the Cycle Selector to any 'DRY' cycle.
3. Set the Dry Time knob to '40' minutes.
4. Push the 'ON/OFF' button IN.
5. Activate the Door Switch by inserting a screwdriver tip about 1/4" into the door hook entry hole.
6. Using the screwdriver, move the white-colored slide mechanism to the right until it stops. **HOLD** the mechanism in place while holding the START button IN until the dryer turns on. (Approx. 10 seconds)
7. Place your hand inside the Porthole Diaphragm at the 1 o'clock position to feel for heat and airflow. The airflow should be similar to a hand-held hair dryer on LOW and it should start heating up within 20 seconds. *NOTE: If either the heat or airflow are not present, see "Problem/Testing Procedure Chart" for further troubleshooting help.*
8. Release the Door Switch by pressing and holding the START button. **If you test a model WD2100XC** and the Airflow and Heat Test results are normal but the problem persists, check the dryer exhaust system for obstructions:
 - With the dryer ON, check the airflow exiting from the vent located on the outside wall and clear any obstructions.
 - Disconnect the flex/metal dryer ducting from the back of the machine. With the dryer ON, check the airflow exiting from the back of the machine and clear any obstructions.

-- End --

SPECIAL WINTERIZATION INSTRUCTIONS FOR RV/MARINE INSTALLATIONS:

To winterize washer-dryer,		To use washer-dryer again,	
WINTERIZE	<ol style="list-style-type: none"> 1. With washer-dryer power OFF, pour ½ quart of RV-type antifreeze into washer drum; 2. Close door. Advance Cycle Selector to 'Spin'; 3. Press ON/OFF button, then press START. let the washer-dryer run for 1 to 2 minutes; 4. Press ON/OFF button to turn power OFF. 	WINTERIZE	<ol style="list-style-type: none"> 1. Reconnect water inlet hoses to corresponding HOT/COLD faucets. Turn faucets ON. <i>NOTE: Check water inlet hoses and pump periodically (see Users Guide);</i> 2. Plug washer-dryer into appropriate electrical outlet (see Users Guide) - OR reconnect power supply; 3. With washer-dryer power OFF, pour 1/2 TBSP. of powder detergent (or liquid equiv.) into compartment '2' inside Dispenser Drawer; 4. Advance Cycle Selector to position '9'; 5. Press ON/OFF button, then press START.
END	<ol style="list-style-type: none"> 5. Unplug washer-dryer from electrical outlet (or disconnect power); 6. Turn water supply faucets OFF. Disconnect inlet hoses from faucets; 7. Drain remaining water from the hoses. FINISHED. 	END	<ol style="list-style-type: none"> 6. Allow machine to run through the complete cycle to clean out any remaining antifreeze. FINISHED.

Optional Winterization Instructions

Winteriza Option	<p>If you're currently pumping antifreeze through your fresh water system, you can follow these steps to winterize your washer-dryer:</p> <ol style="list-style-type: none"> 1. With machine power OFF, turn WASH TEMP knob to 'HOT'; 2. Advance Cycle Selector to position '3'; 3. Press ON/OFF button, then press START. Let machine fill until the drum turns (could take up to 1 to 2 minutes); 4. Press ON/OFF button to turn power OFF; 5. Advance Cycle Selector to 'Spin'; 6. Press ON/OFF button, then press START.
END	<ol style="list-style-type: none"> 7. After letting antifreeze drain completely from drum, press the ON/OFF button to turn power OFF. FINISHED. TO USE YOUR WASHER-DRYER AGAIN, SEE INSTRUCTIONS ABOVE

Verifying Normal Operation

Follow these steps in the order they are listed to test the washer-dryer for normal operation. We recommend that you ALWAYS perform this test as the last step of your repair. It takes approximately 8 min. to complete.

Introduction

The following instructions explain how to test the washer-dryer to make sure everything's working properly. Keep in mind, this appliance operates differently than some of the previous Splendide models you may be familiar with.

It's important to note the following differences:

- The timer WILL NOT advance like a traditional, mechanical timer. It only sends a signal to the control board.
- All of the timing is controlled by a microprocessor on the board, so the Dry Time knob WILL NOT move, or "count down" the time.

Before beginning the test, remove all items from the drum and close the door.

Step	You Select	Correct Washer-Dryer Response	Components Checked
1	Press 'ON/OFF' button	Power to unit will turn ON	Control Panel Board, Module Board
2	Press and HOLD 'START' button for 5 seconds	Controls will clear. All LED's will turn ON then OFF, then the DOOR LOCK LED will blink	LED's
3	Set DRY TIME knob to '40' Set CYCLE SELECTOR to '4' Press 'START' Button	Fill by water inlet valves. Two-way basket rotation.	Inlet Valves, Door Lock System, Main Motor
4	Cancel the cycle by PRESSING and HOLDING the 'START' button for 5 seconds		
5	Set CYCLE SELECTOR to 'Spin' Press 'START' Button	Drain Pump turns ON. Basket rotates and ramps up.	Drain Pump, Main Motor.
6	Cancel the cycle by PRESSING and HOLDING the 'START' button for 5 seconds		
7	Set CYCLE SELECTOR to '5' Press 'START' Button	Fan turns ON. Two-way basket rotation.	Fan Motor.
8	Cancel the cycle by PRESSING and HOLDING the 'START' button for 5 seconds		
9	Press 'ON/OFF' button	Power to unit will turn OFF	

-- End --

Wiring Diagrams

WD2100XC / WD2100XCP / WD7100XCP

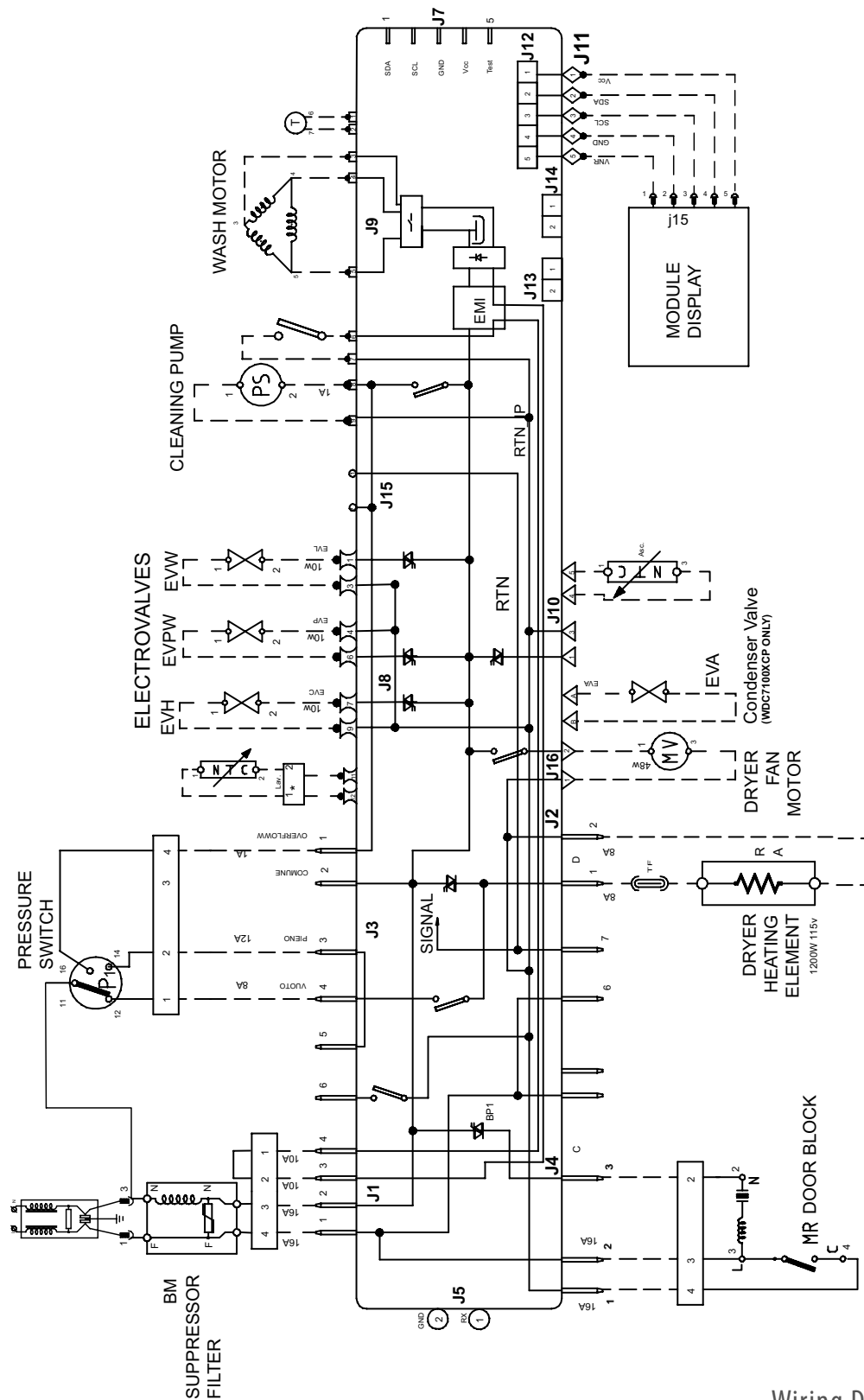

WD2100XC / WD2100XCP / WD7100XCP

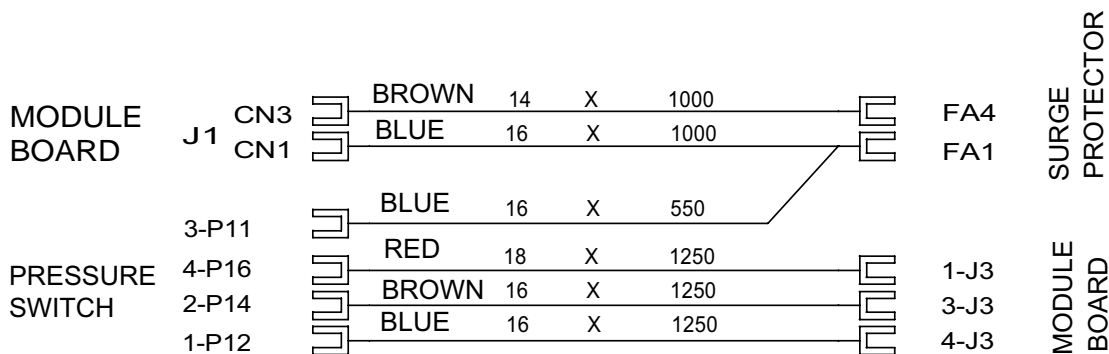

A = WIRING ASSEMBLY MODULE - BOARD - SURGE PROTECTOR - PRESSURE SWITCH

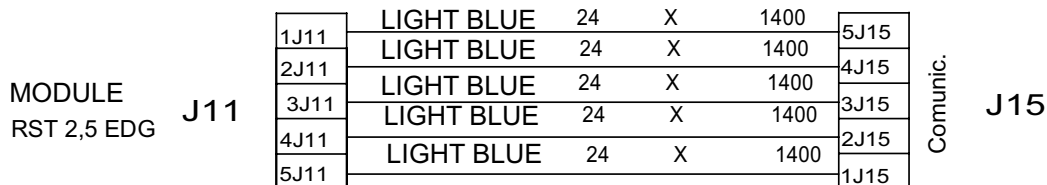

B1 = WIRING ASSEMBLY MODULE - DISPLAY

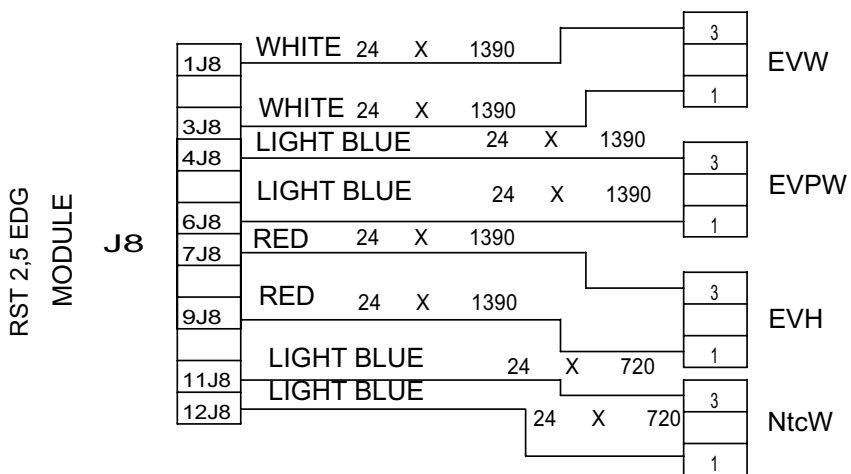

C = WIRING ASSEMBLY MODULE - EVW - EVPW - EVH - NtcW

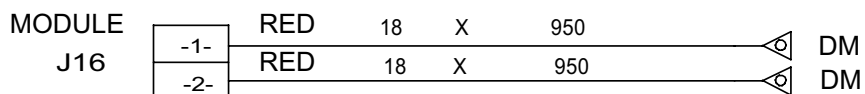

G = WIRING ASSEMBLY MODULE - DRY MOTOR

WD2100XC / WD2100XCP / WD7100XCP

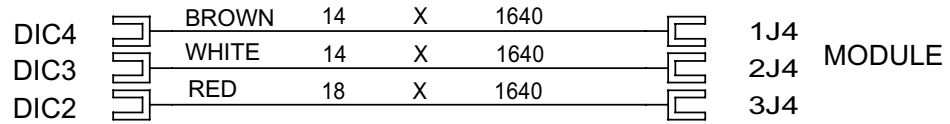

D1 = WIRING ASSEMBLY MODULE - DOOR INTERLOCK

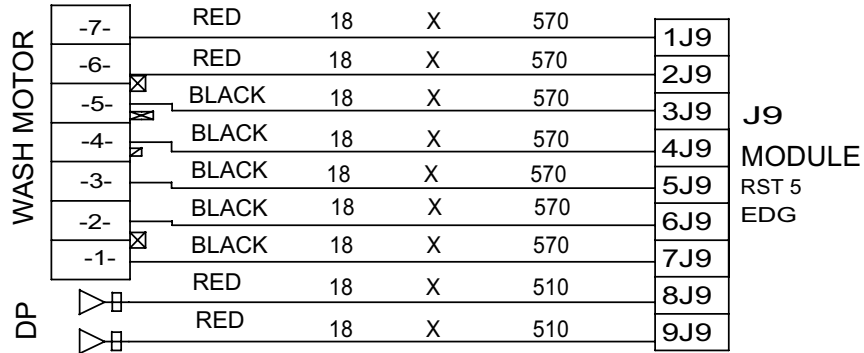

L = WIRING ASSEMBLY MODULE - DRAIN PUMPE - WASH MOTO

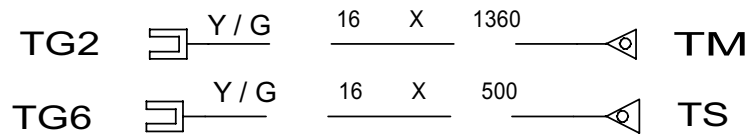

Y = WIRING ASSEMBLY EARTH MACHINE

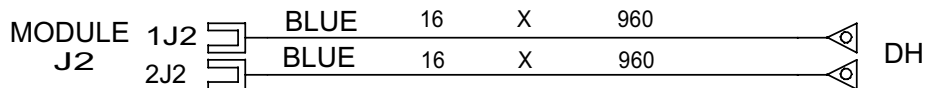

H = WIRING ASSEMBLY MODULE - DRY HEATER

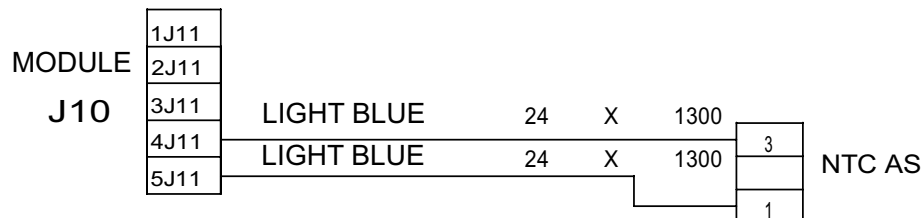

COMPLESSIVO P = NTC ASCIUGATURA

P = WIRING ASSEMBLY MODULE - NTC DRY



Splendide®

© Copyright 2007, Westland Sales, Clackamas, OR 97015